

Optimization  
for Machine Learning  
in Practice II

Martin Jaggi

**EPFL**

*Machine Learning and Optimization Laboratory*

*[mlo.epfl.ch](http://mlo.epfl.ch)*



2

# Collaborative Learning



# Evolution

## centralized

traditional, sharing data

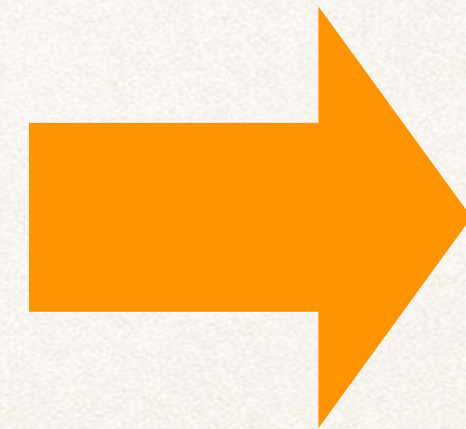
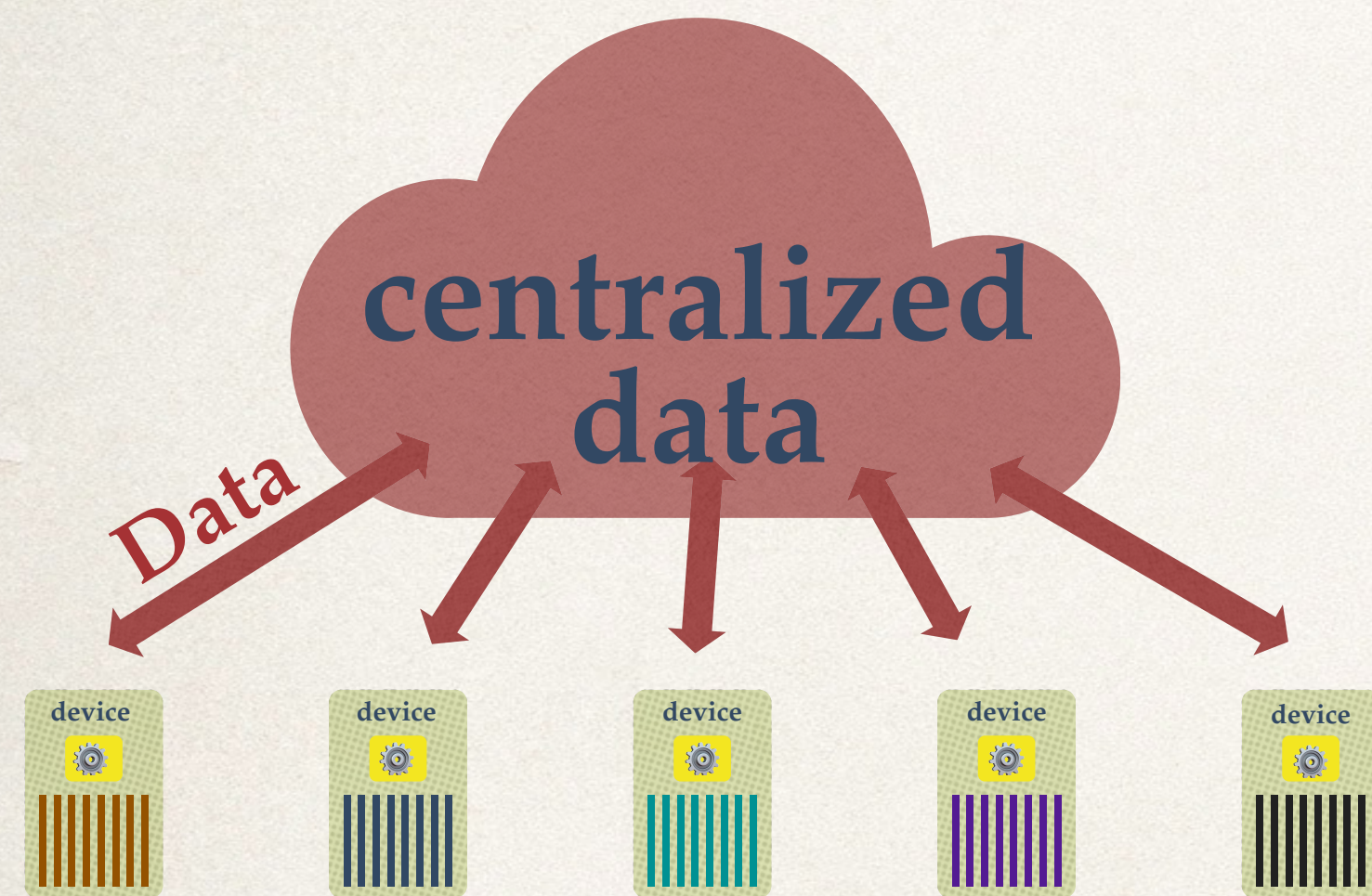

## federated

sharing model updates

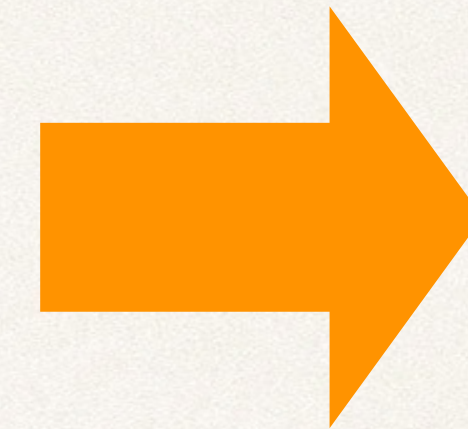
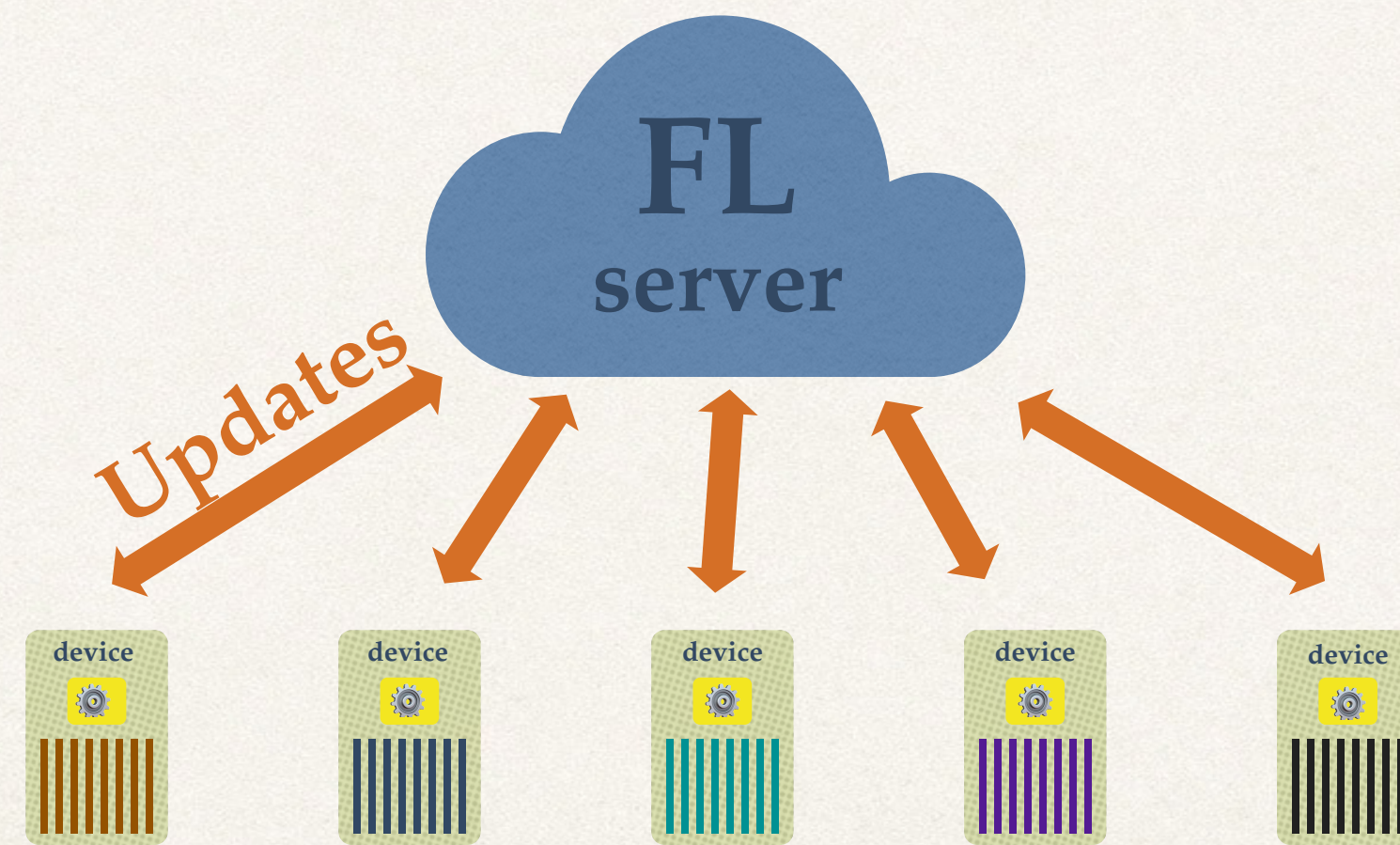

## decentralized

collaborative learning

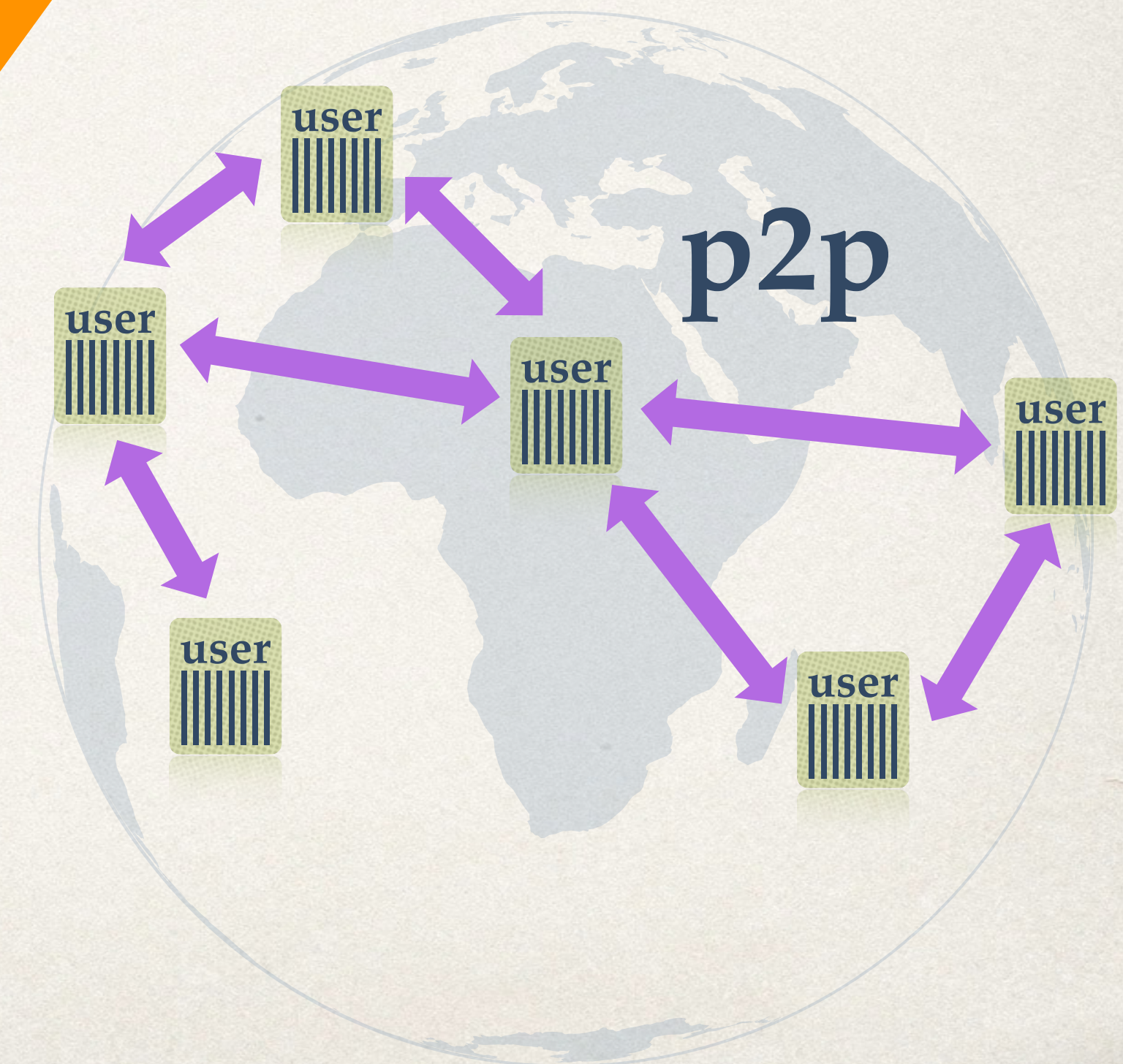



# Collaborative & Federated Training

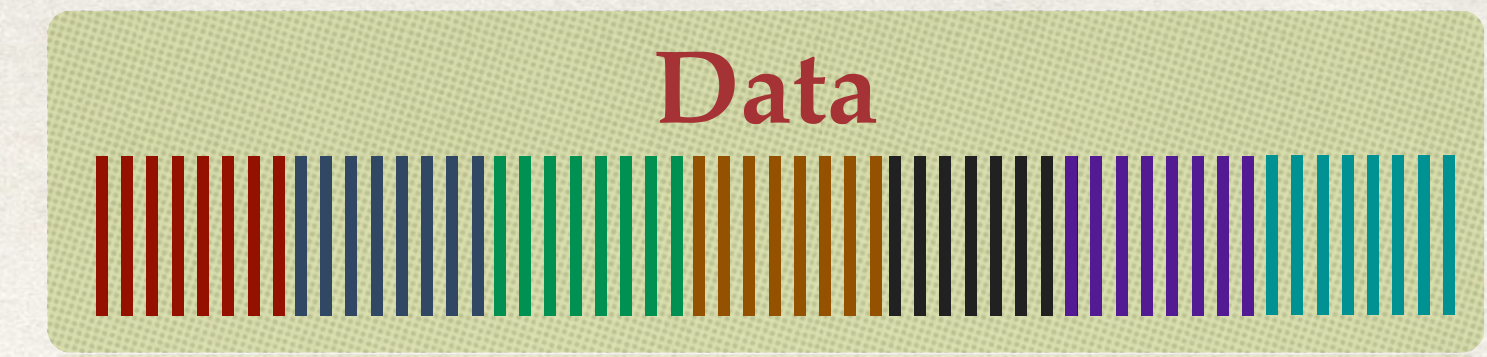

(recap)

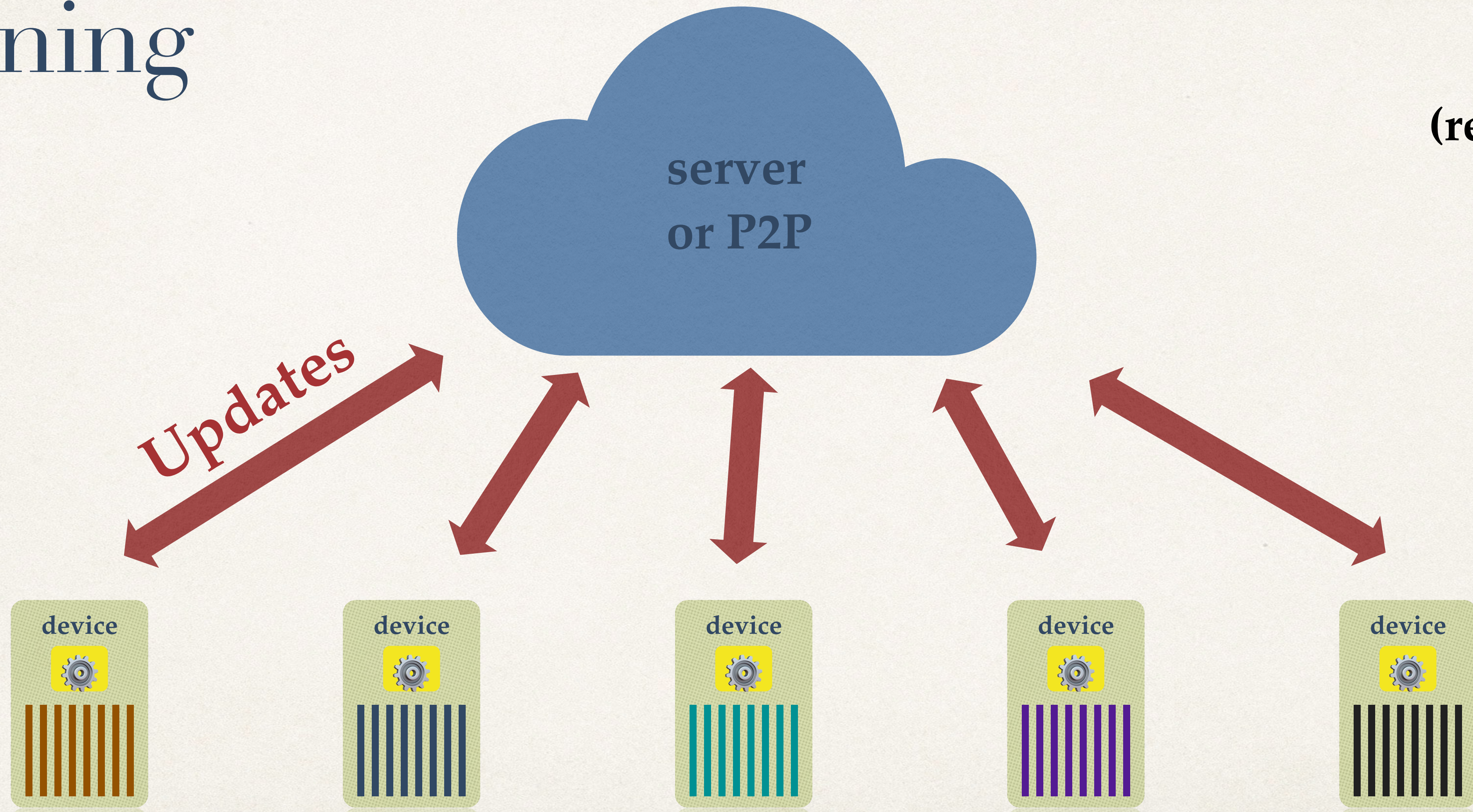



# Big Picture

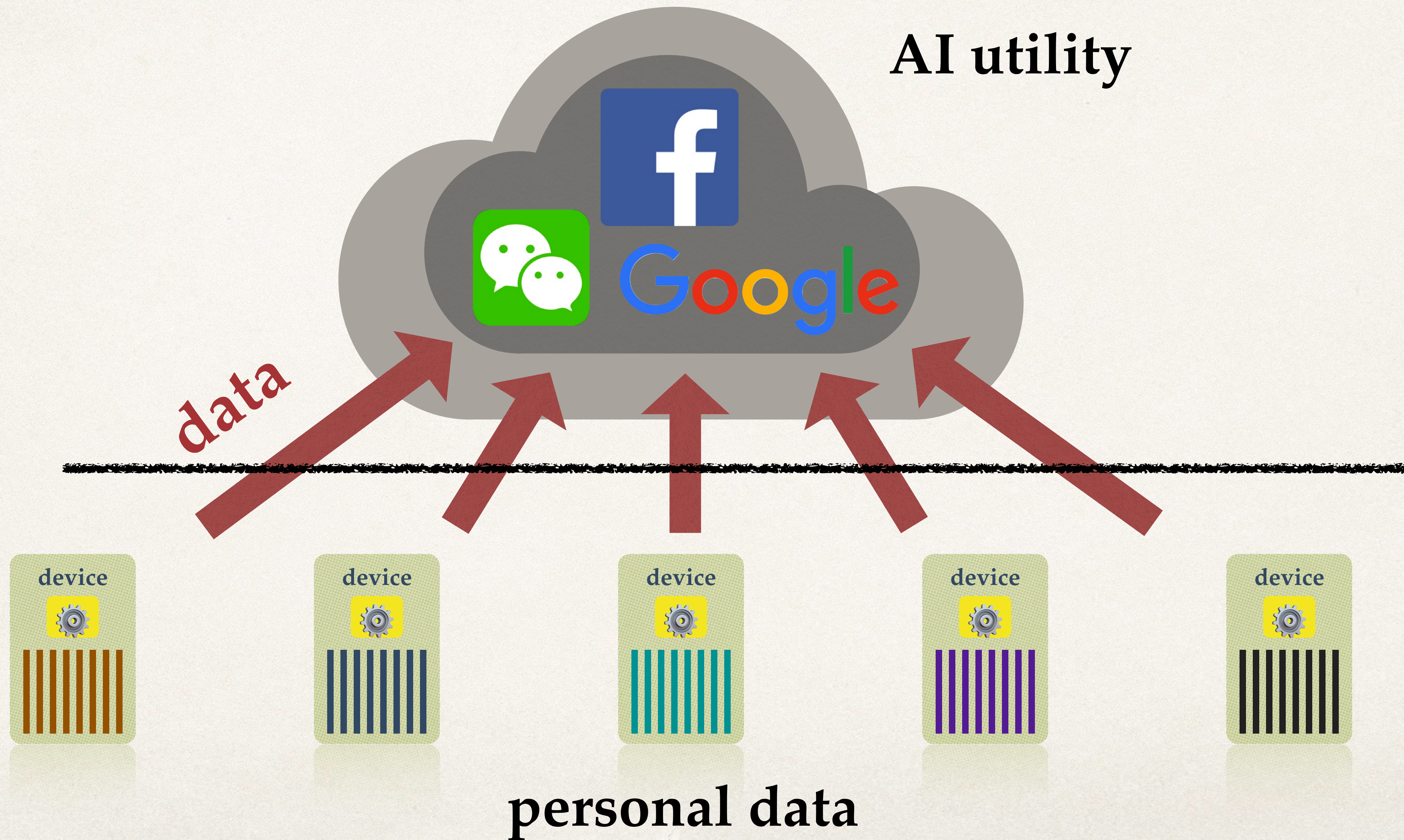



2a

# Federated Learning

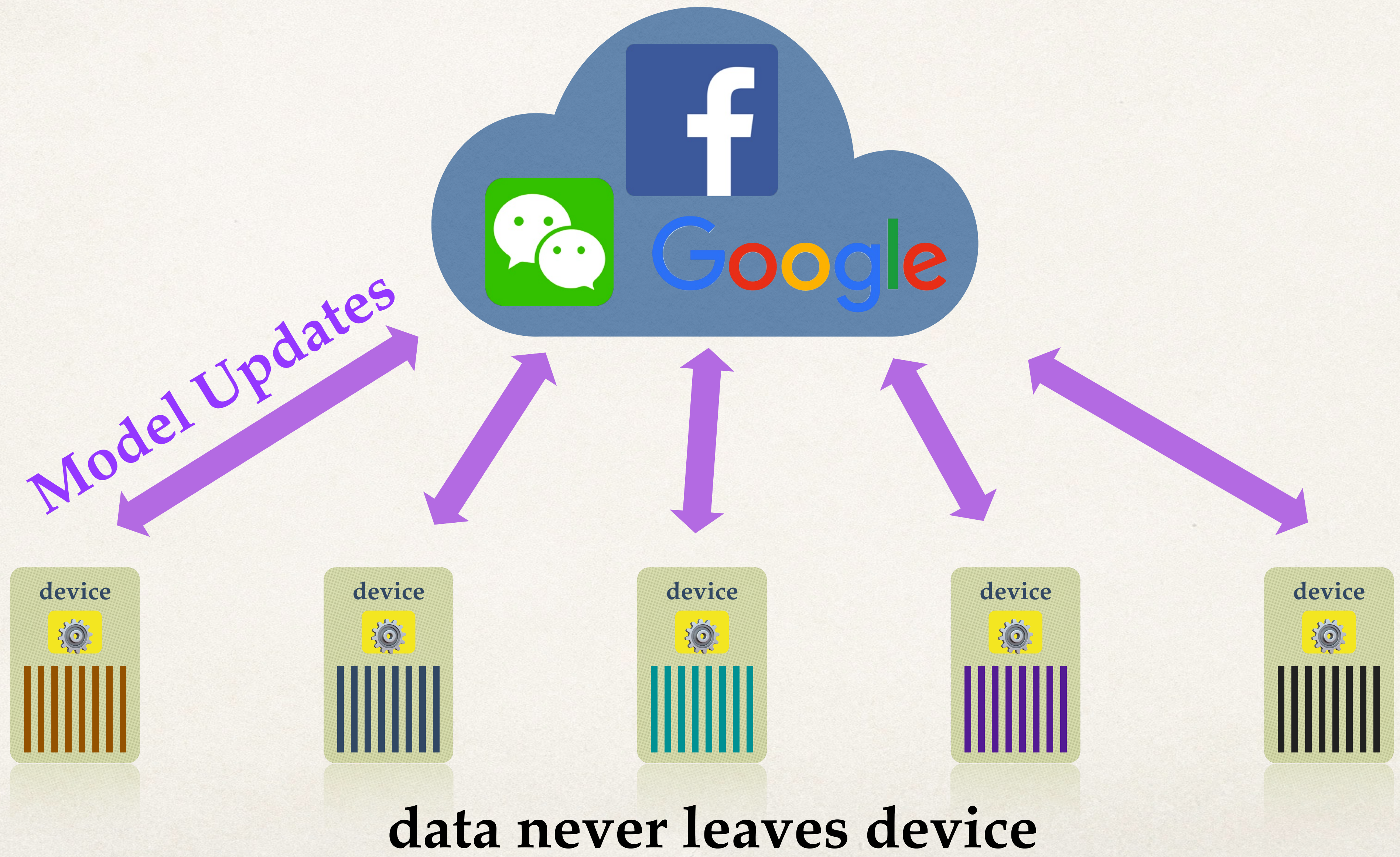



# 2a

# Federated Learning

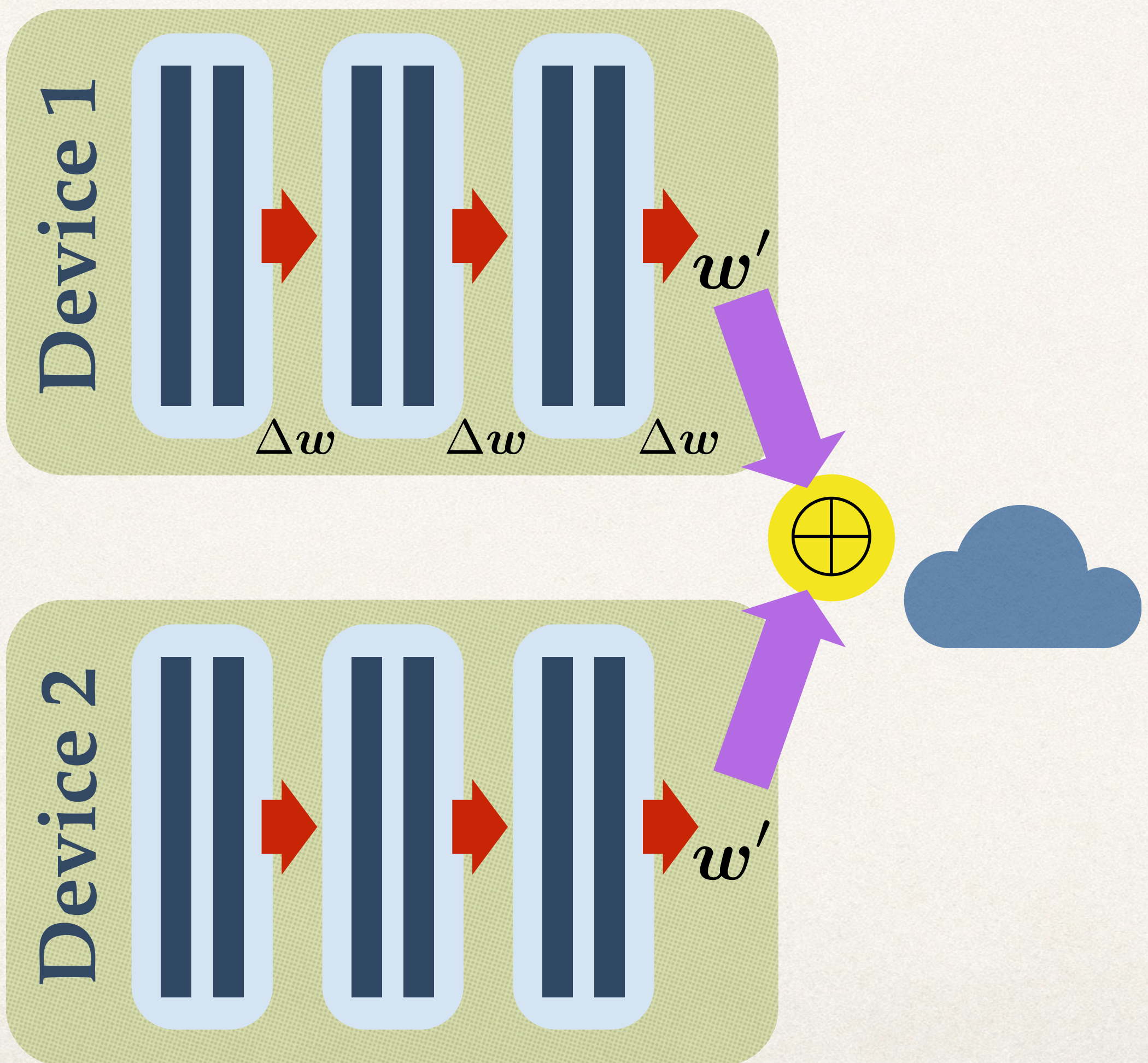

- ❖ Local SGD steps = "Federated averaging"
- ❖ Google Android Keyboard



# Client drift

- ❖ Federated Learning

$$\min_{\mathbf{x}} \frac{1}{n} \sum_i^n f_i(\mathbf{x})$$

- ❖ Fed Avg / Local SGD

*for some local steps*

$$\mathbf{y}_i := \mathbf{y}_i - \eta \nabla f_i(\mathbf{y}_i)$$

$$\mathbf{x} := \frac{1}{n} \sum_{i=1}^n \mathbf{y}_i \quad (\text{aggregation})$$

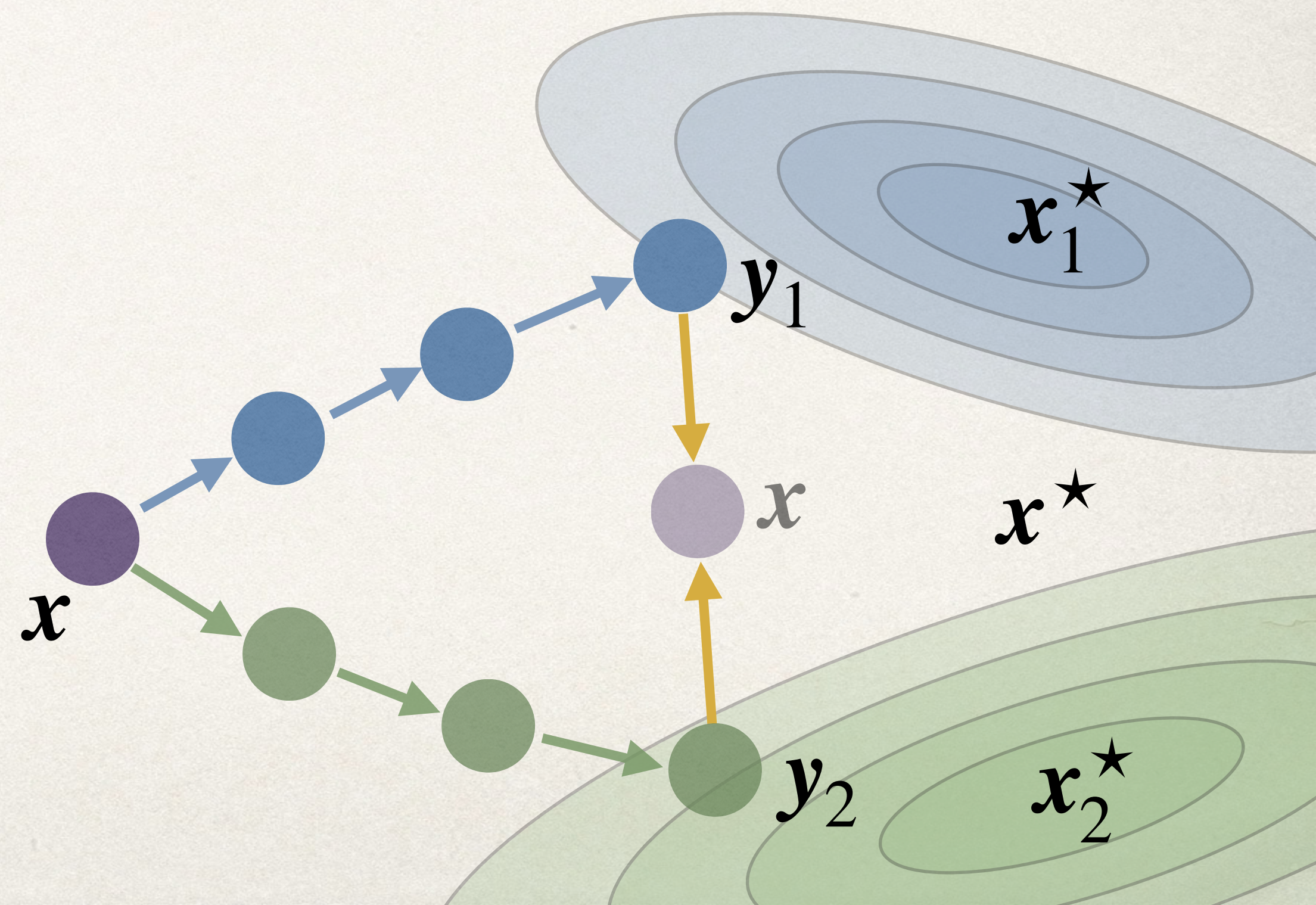
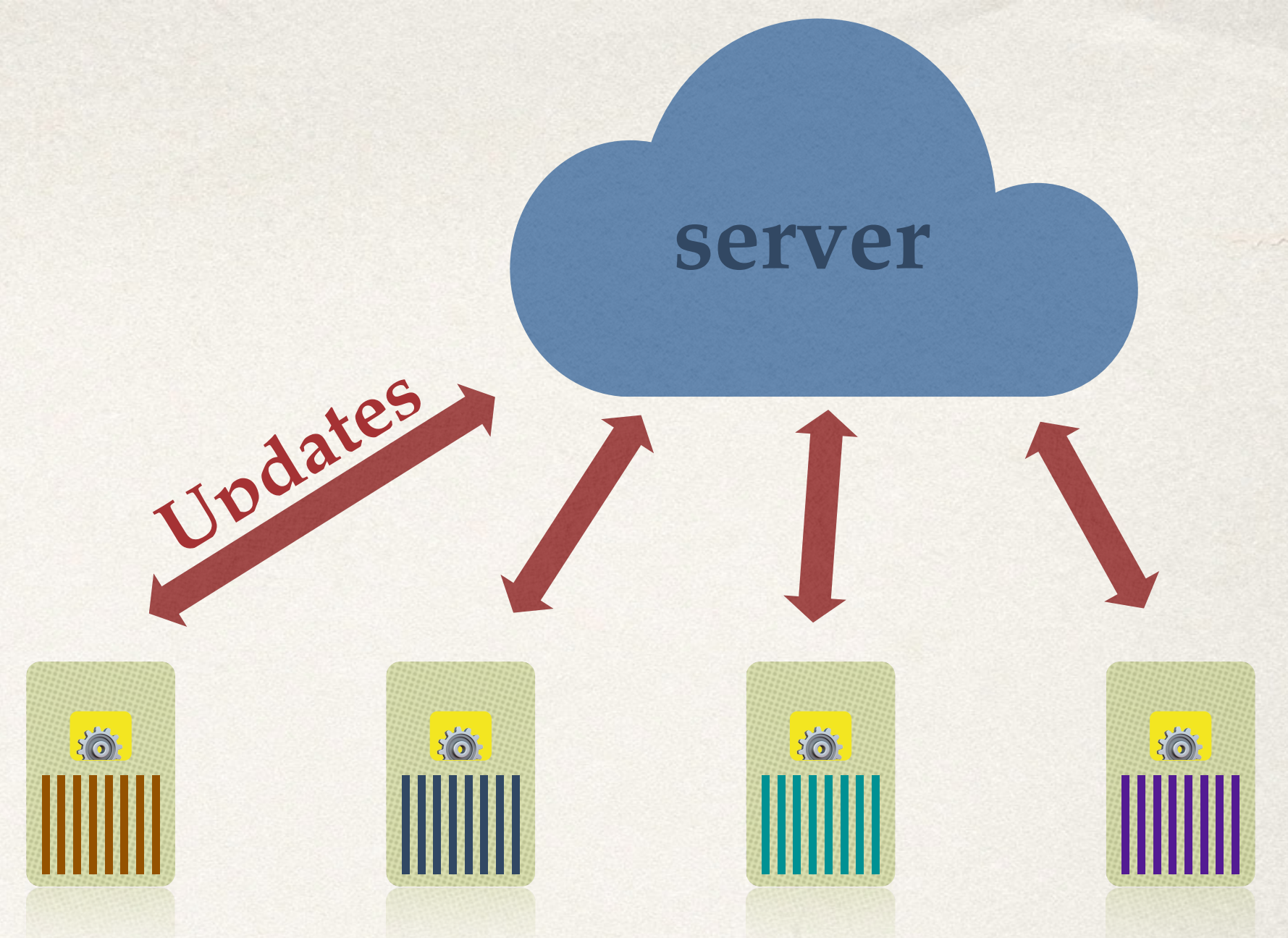



# Client drift

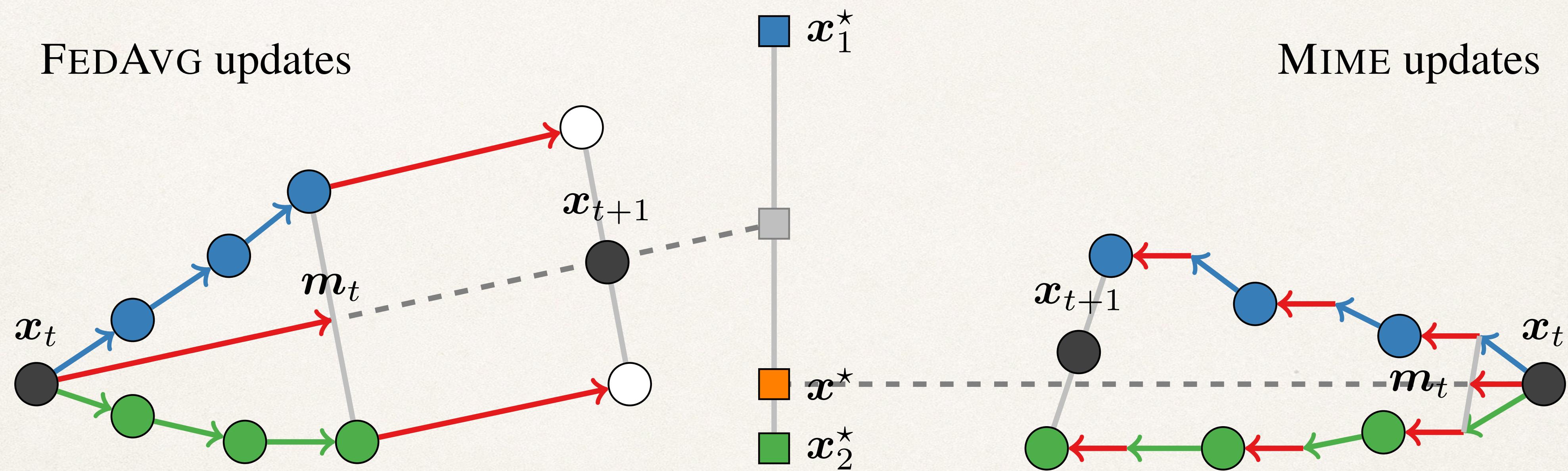



# Mime algorithm framework

*for some local steps*

$$\mathbf{y}_i := \mathbf{y}_i - \eta \left( (1 - \beta) \nabla f_i(\mathbf{y}_i) + \beta \mathbf{m} \right)$$

$$\mathbf{m} := (1 - \beta) \nabla f_i(\mathbf{x}) + \beta \mathbf{m}$$

*aggregated on server  
after each round*





# 2b

# Federated vs Personalized Learning

❖ Federated

$$\min_x \frac{1}{n} \sum_i^n f_i(\mathbf{x})$$

❖ Collaborative / Personalized

$$\min_x f_0(\mathbf{x})$$

$$\min_x f_1(\mathbf{x})$$

$$\min_x f_n(\mathbf{x})$$

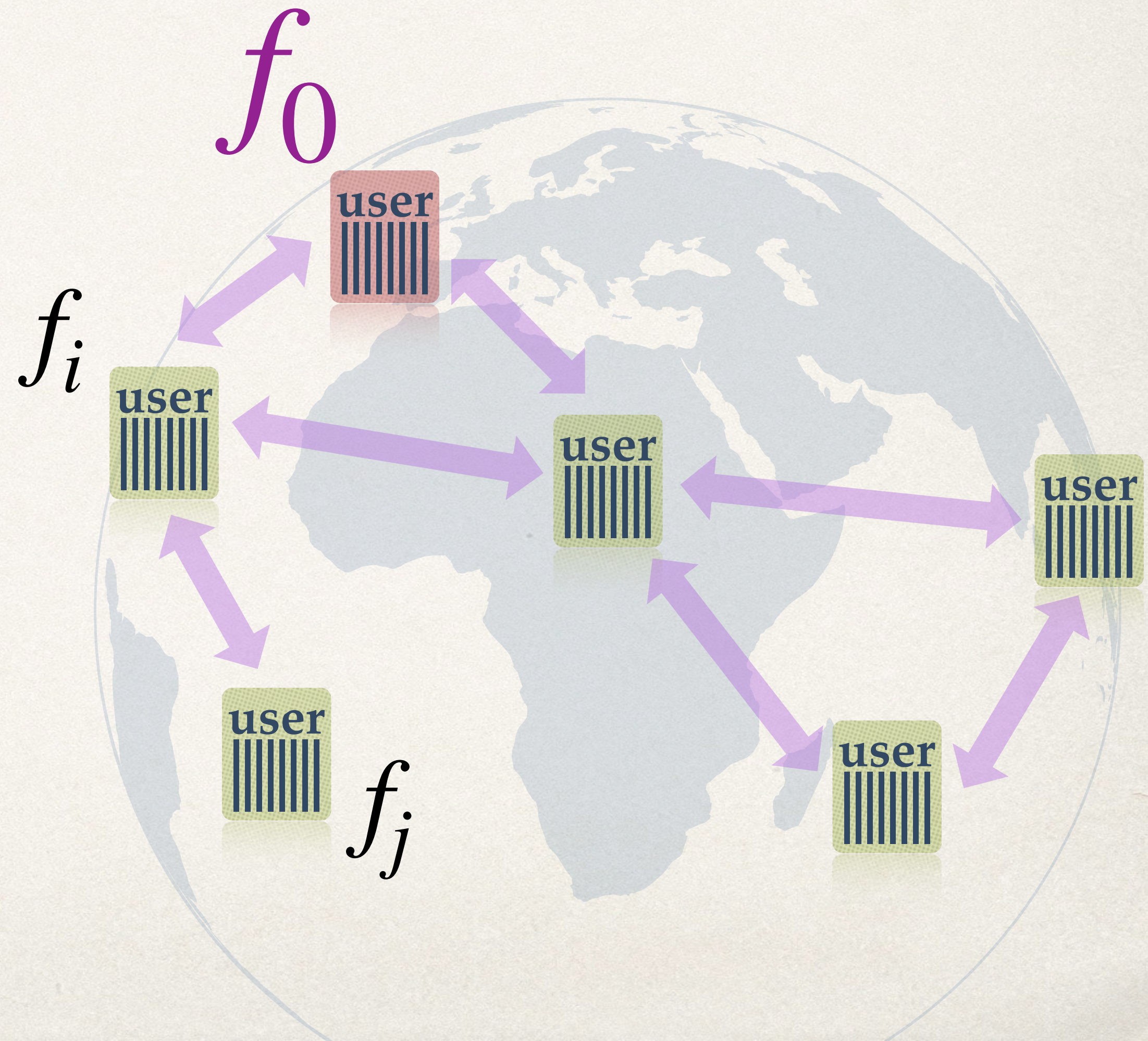



# 2b

## Federated vs Personalized Learning

- ❖ **Federated**

$$\min_{\mathbf{x}} \frac{1}{n} \sum_i^n f_i(\mathbf{x})$$

- ❖ **Collaborative / Personalized**

$$\min_{\mathbf{x}} f_0(\mathbf{x})$$

$$\min_{\mathbf{x}} f_1(\mathbf{x})$$

$$\min_{\mathbf{x}} f_n(\mathbf{x})$$

- ❖ **Ordering of training**

Set of active clients evolves (how?)

- ❖ **Clients = Tasks**

Sequential fine-tuning

Transfer learning,

overparameterized models?

- ❖ **Train alone or collaborate?**



2c

# Decentralized Learning

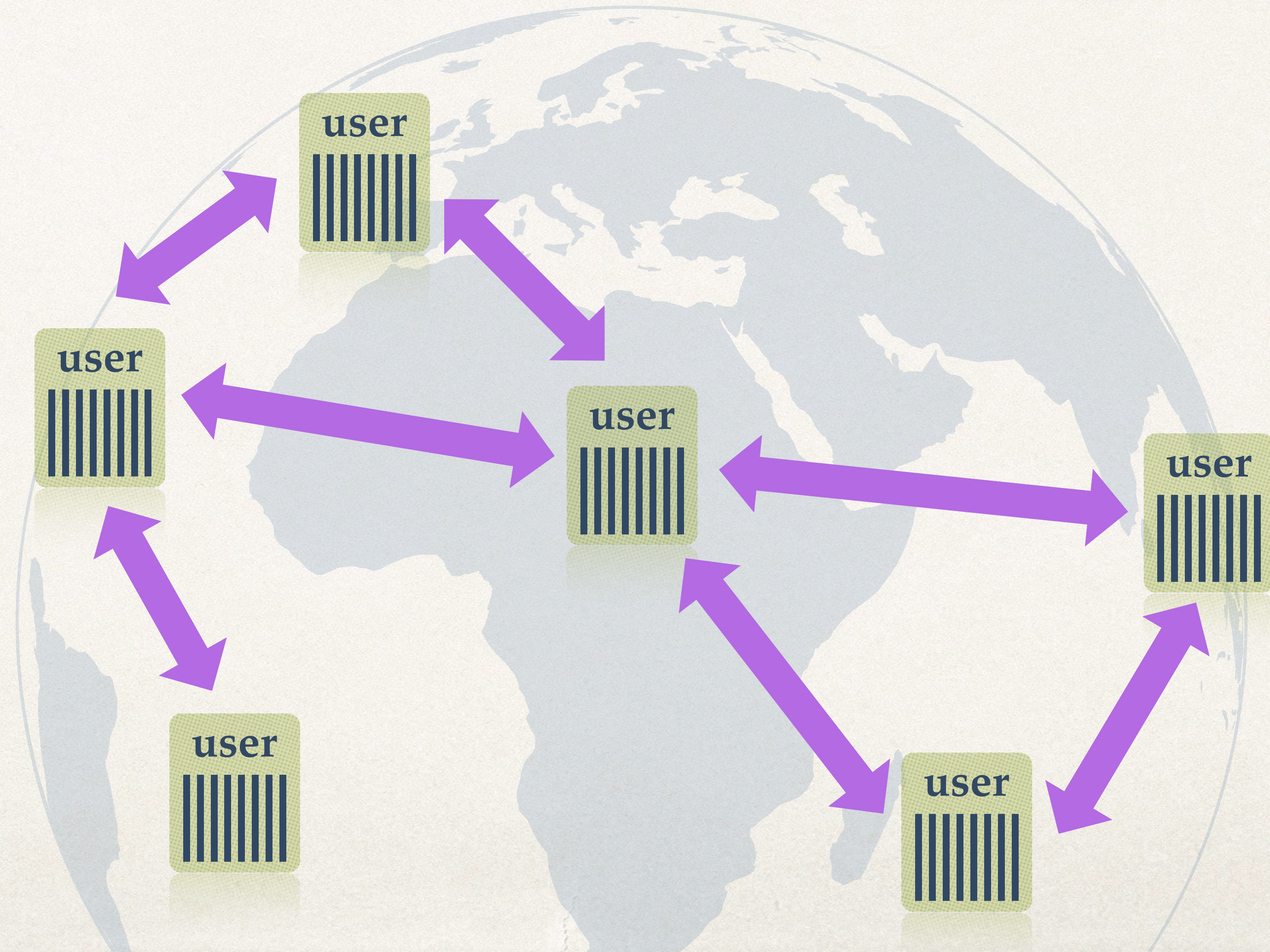



# Motivation

## ❖ Applications:

any ML system with user data  
servers, devices, sensors, hospitals, ...



[image source](#)

## ❖ Advantages:

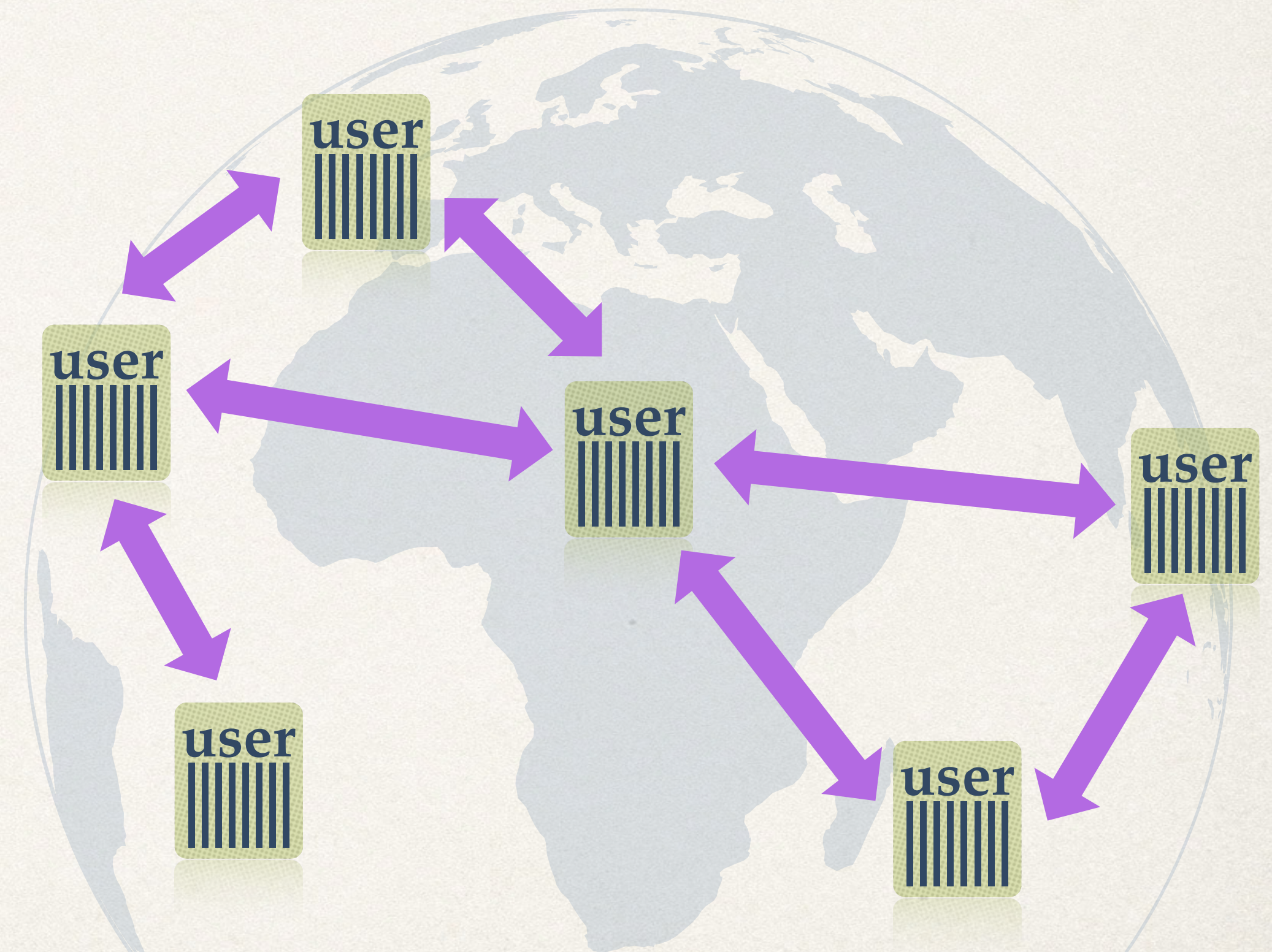

**AI utility, control and privacy  
aligned with data ownership**



# Required Building Blocks

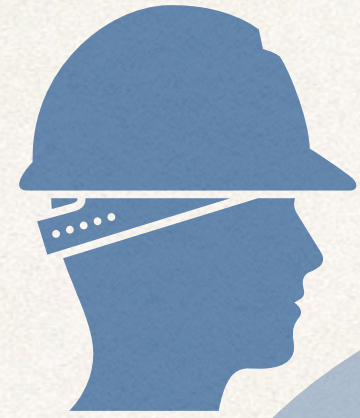

Robustness

Decentralized  
ML

Efficiency



Privacy

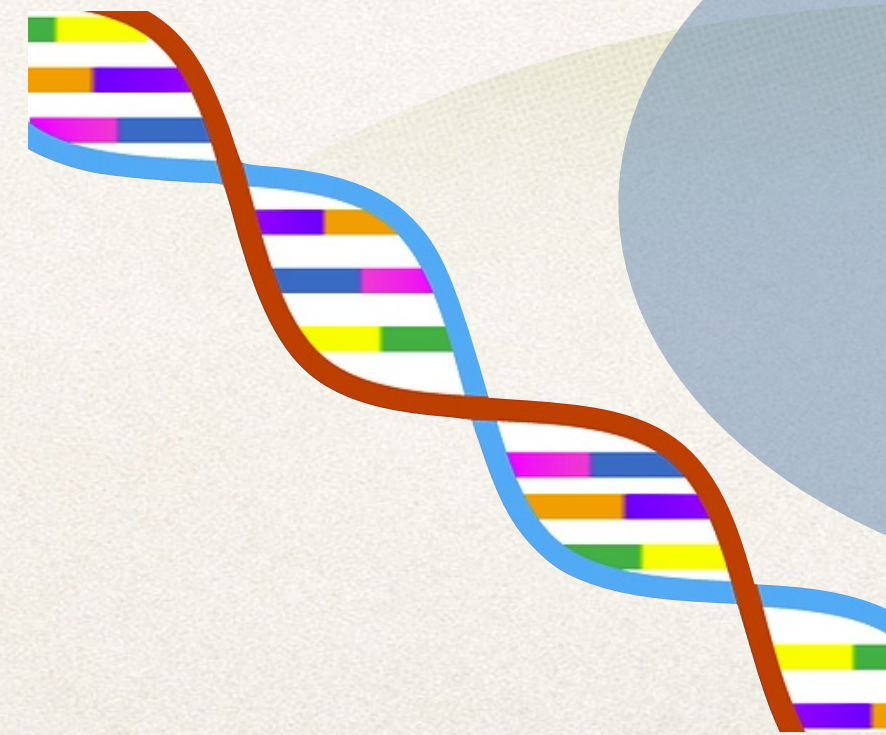



# Decentralized Learning

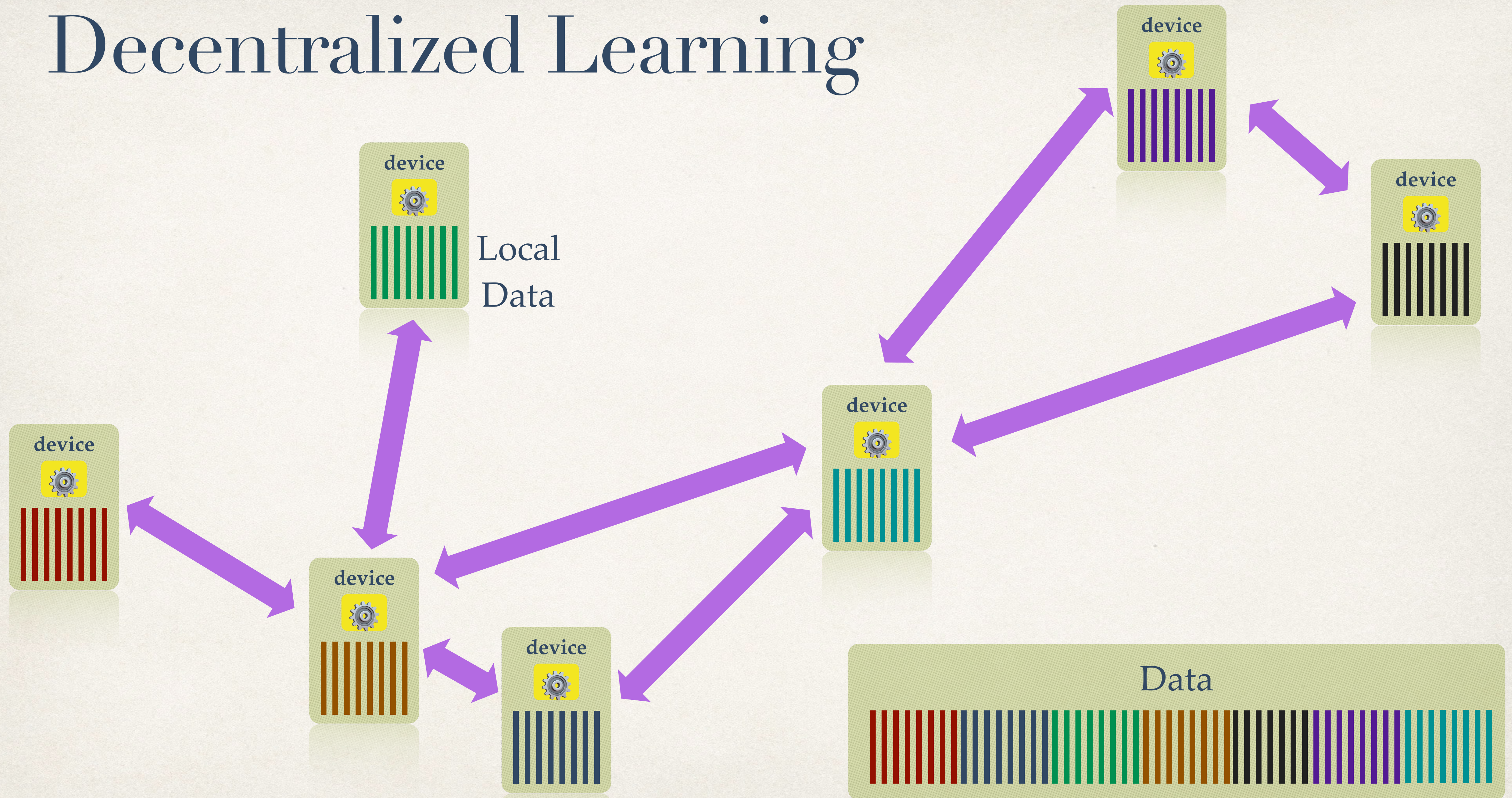



# Decentralized Learning

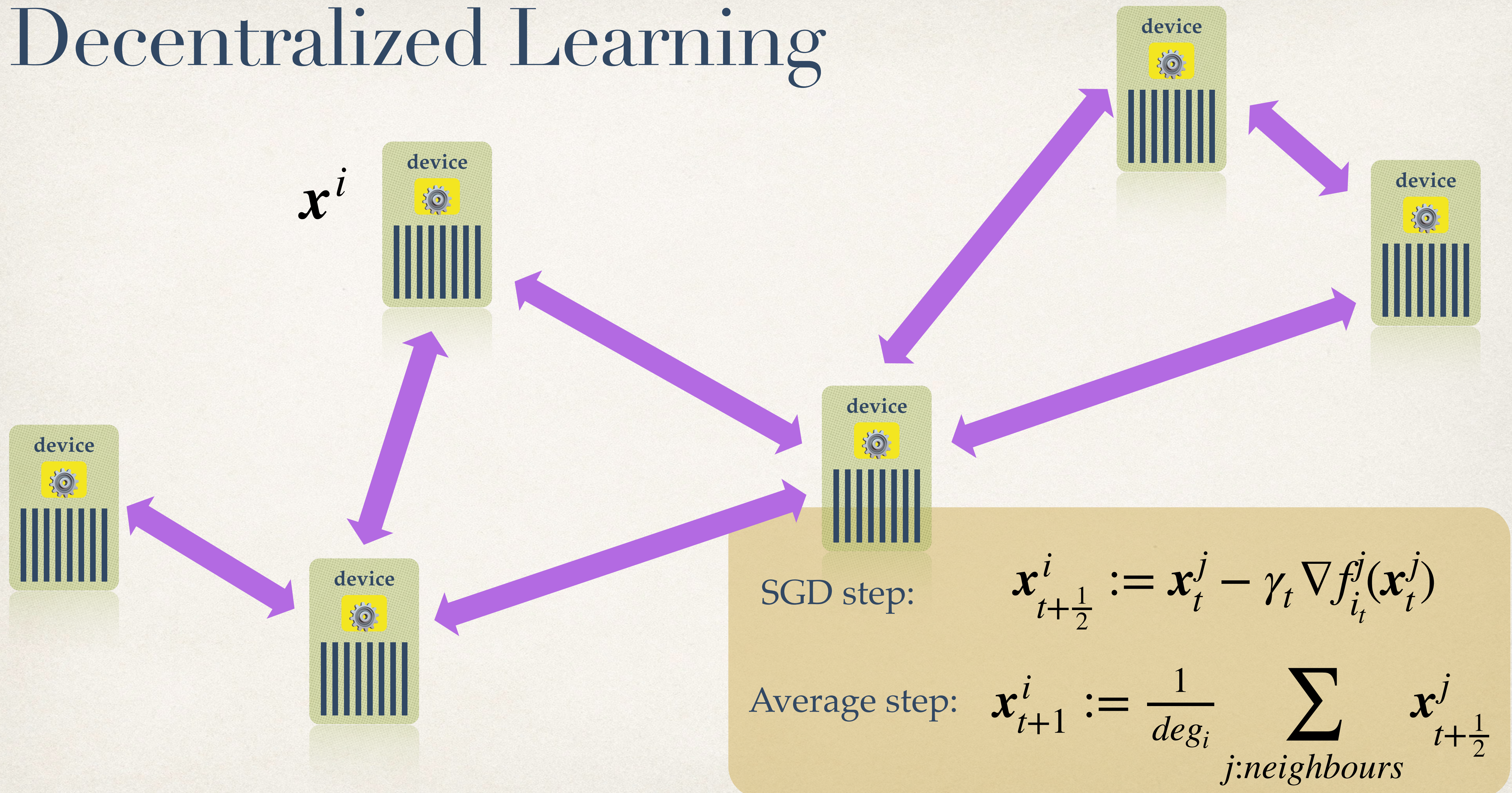



# Communication Compression

- ❖ limited-bit precision vector

e.g. 1-bit per entry reduces communication 32 times

- ❖ random / top  $k\%$  of all the entries

e.g.  $k=0.1\%$  reduces communication 1000 times

- ❖ low rank version of the gradient?



# Low-Rank Communication Compression

- PowerSGD

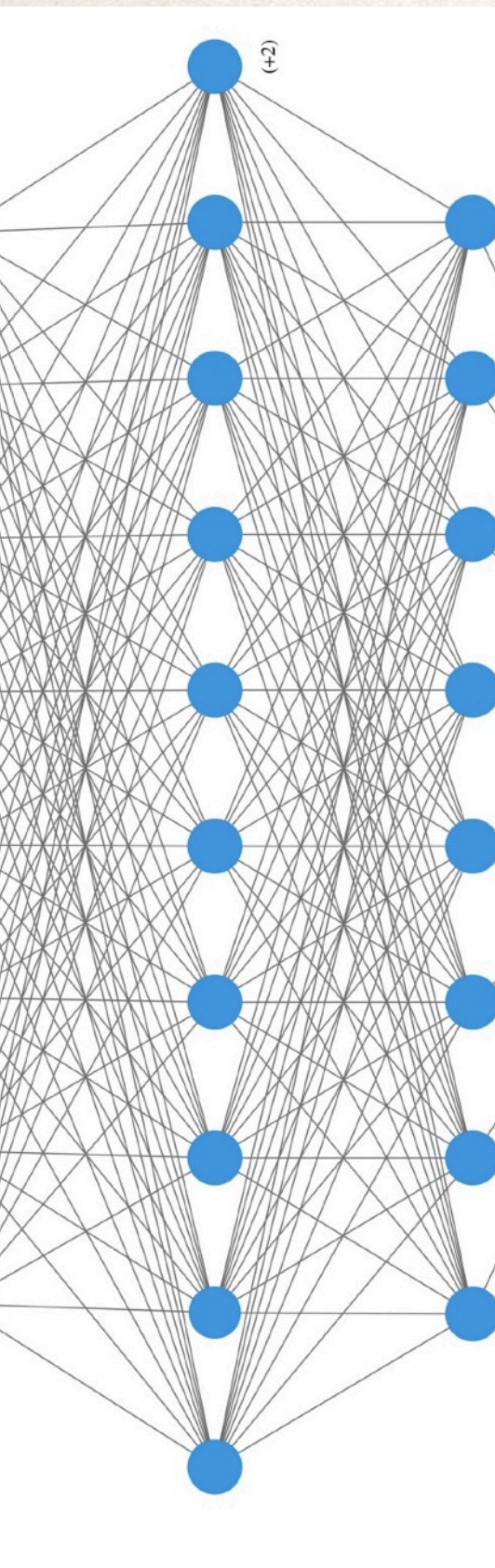

backprop is fast:  
linear time

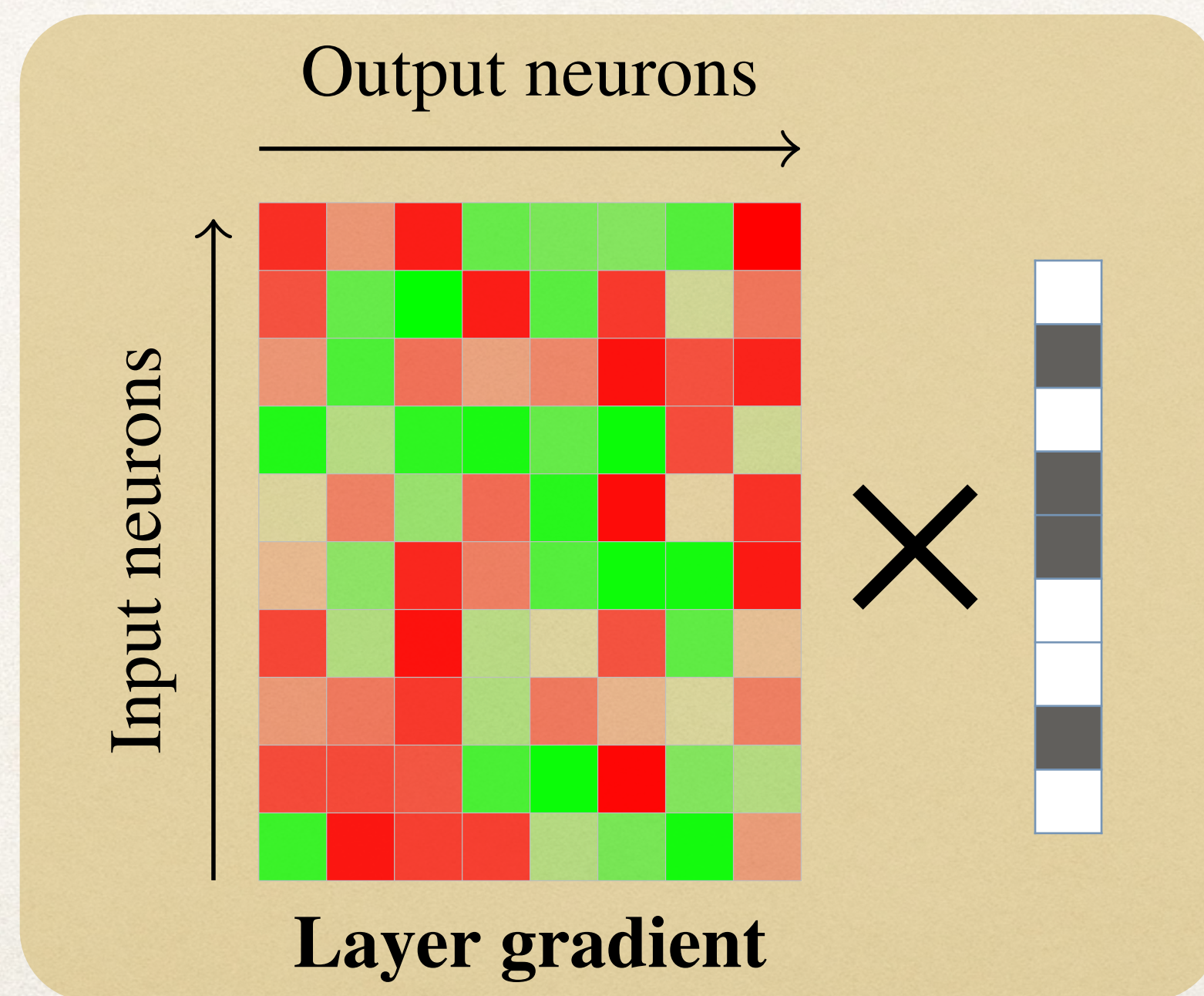

fast compression?

**Fast power iterations**

$$p := Gq$$

$$q := G^T p$$

$$\mathcal{C}(G) = pq^T$$



# Decentralized Learning with Compression

- PowerGossip

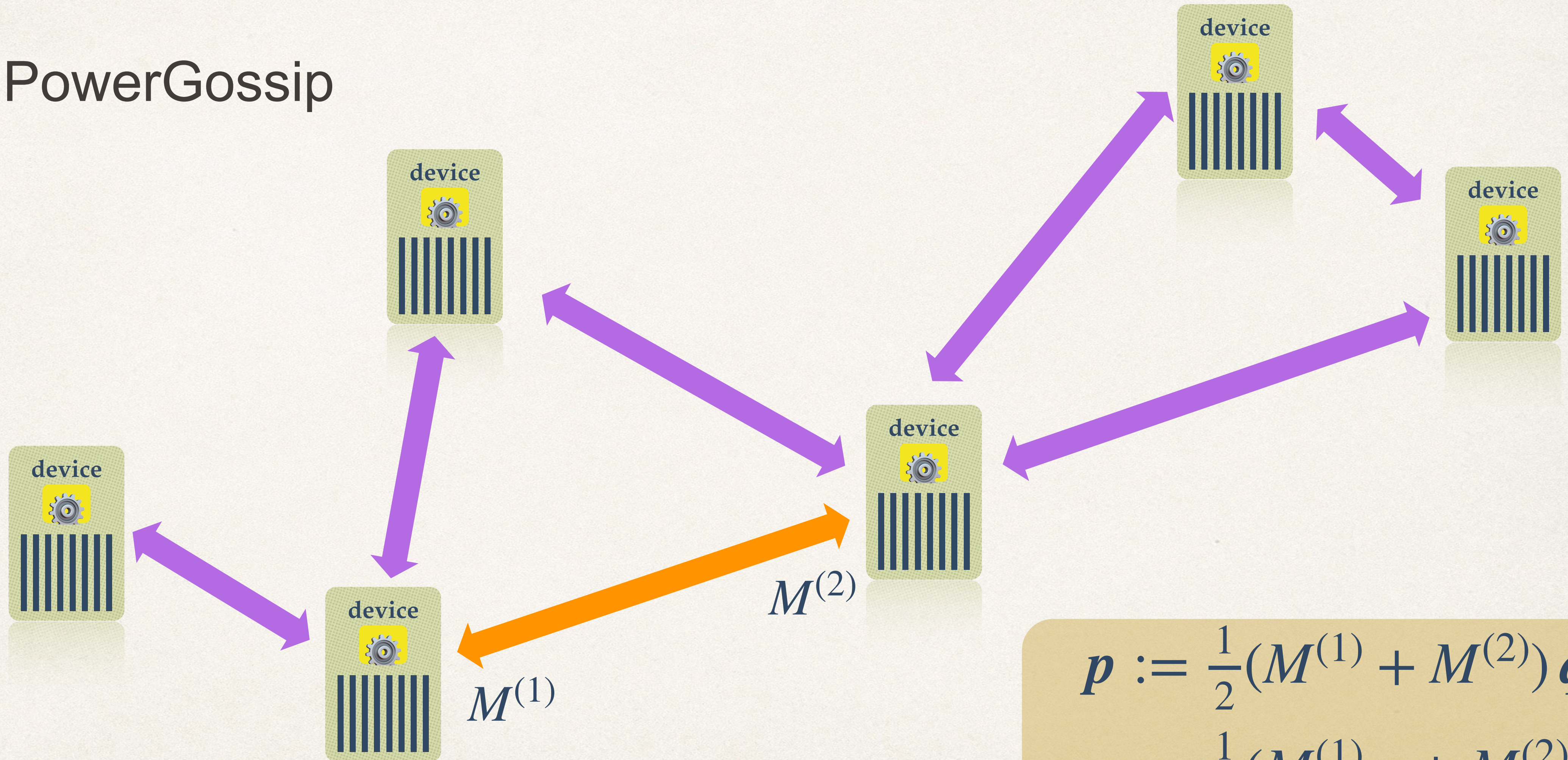

$$p := \frac{1}{2}(M^{(1)} + M^{(2)}) q$$

$$p := \frac{1}{2}(M^{(1)} q + M^{(2)} q)$$



# Building Blocks for Decentralized ML

- ❖ **Efficiency: Communication & Compute**

on-device learning, Edge AI  
peer-to-peer communication

- ❖ **Privacy**

data locality, leakage?, attacks?

- ❖ **Robustness & Incentives**

tolerate bad players, reward collaboration



# 3

## Robustness

During Training and Inference

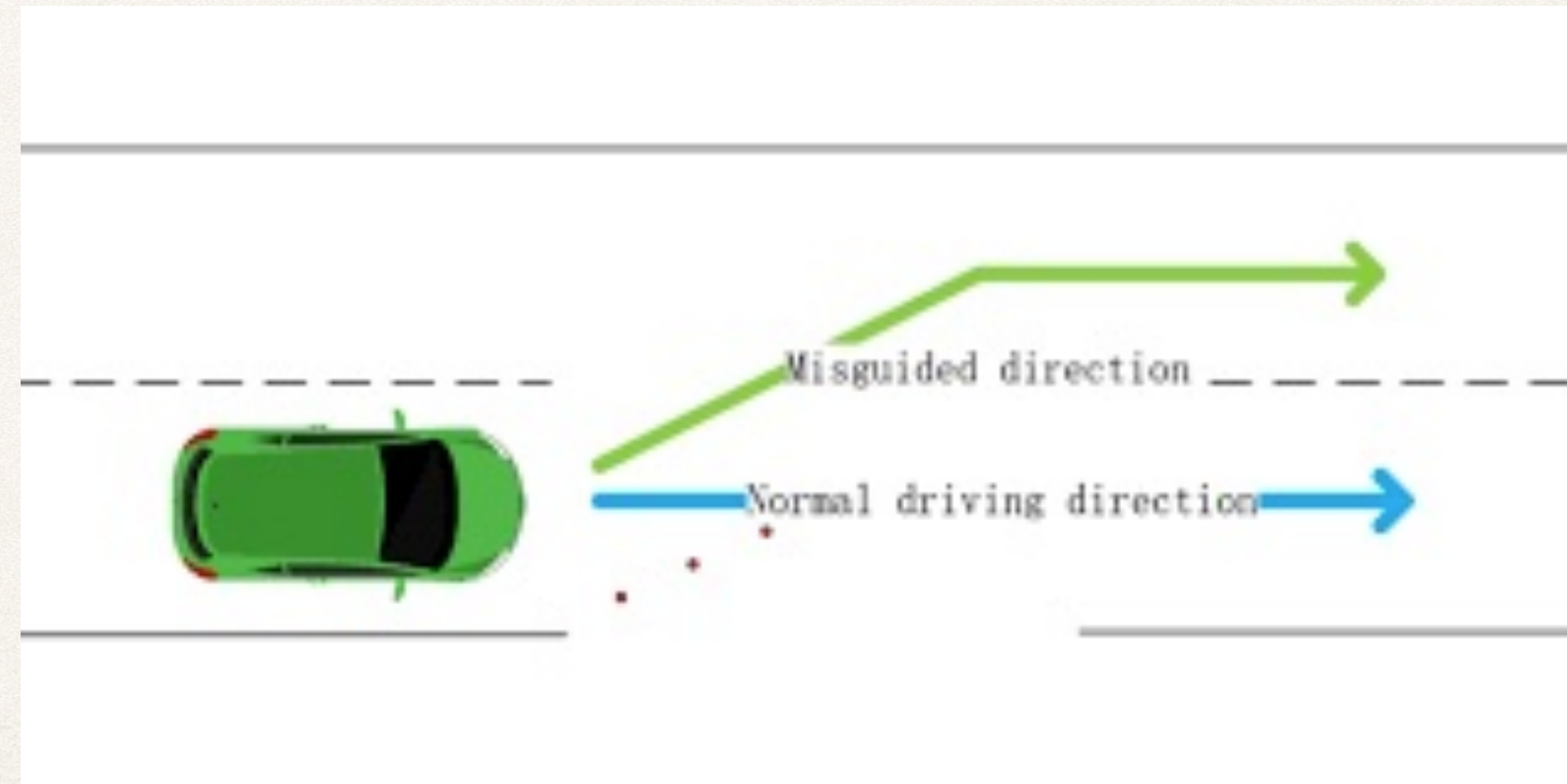



3a

Gradients from  
faulty/malicious collaborators:  
- Byzantine-robust Training



# Malicious actors in FL

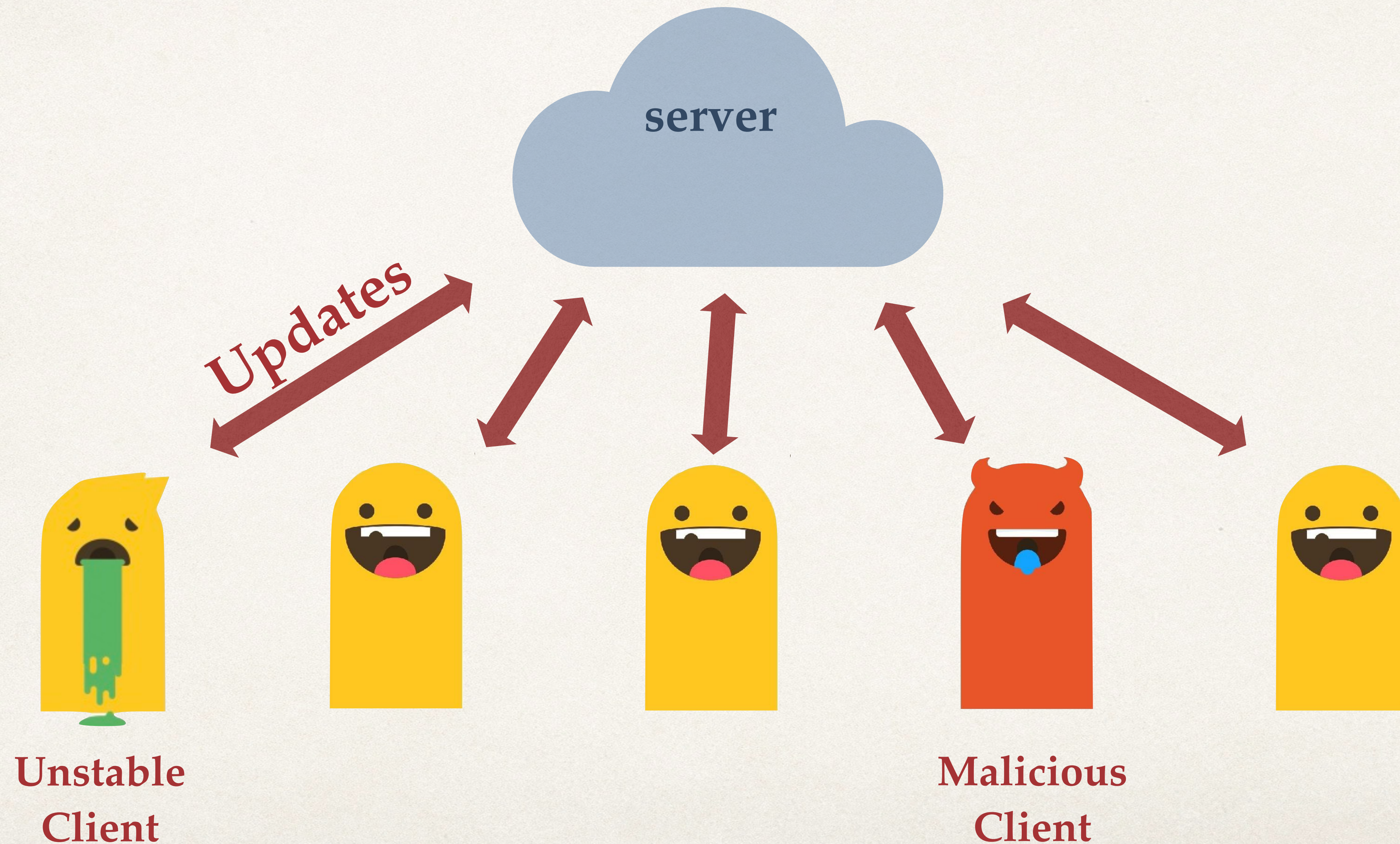



# Byzantine Robust Training

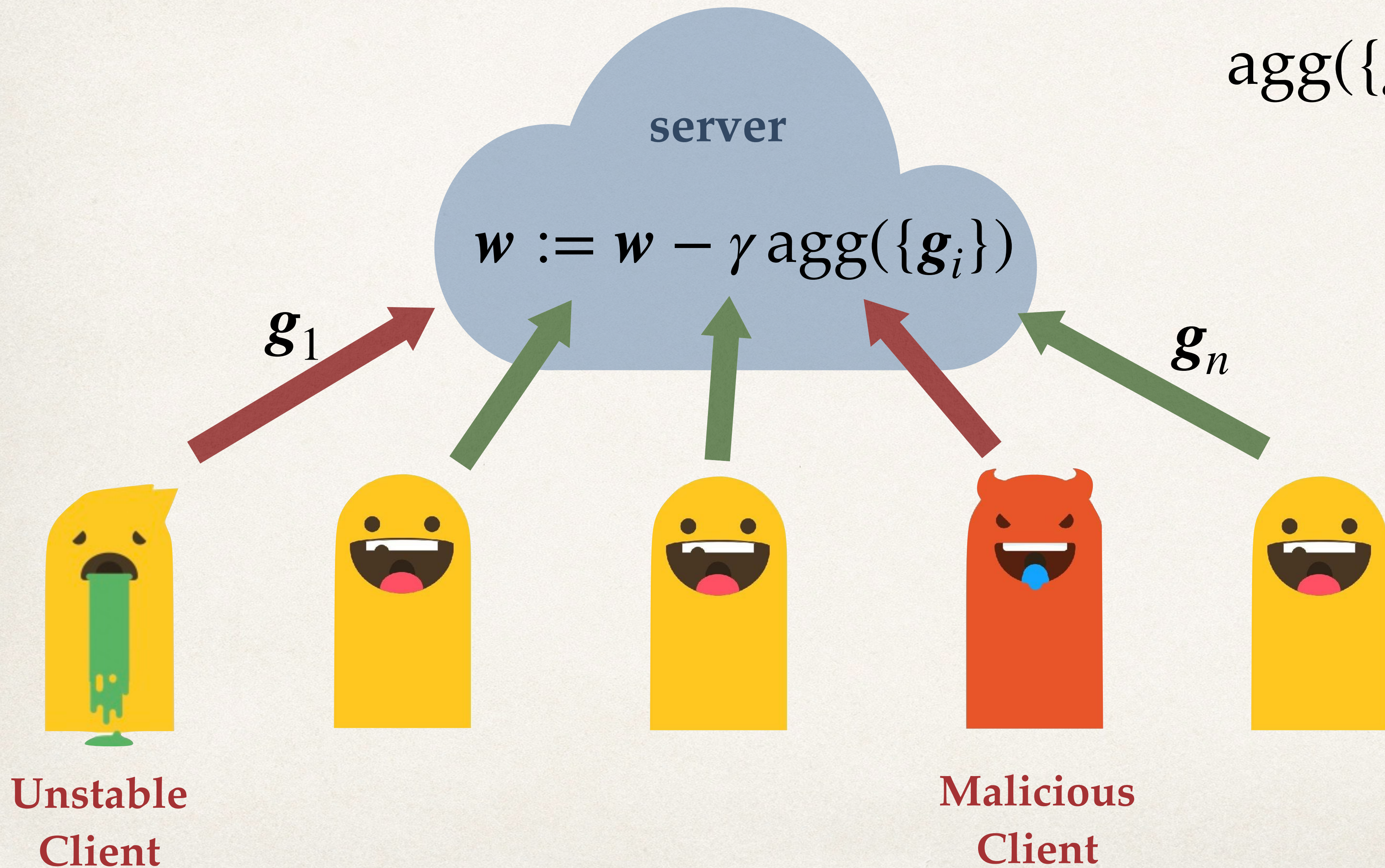

$$\text{agg}(\{g_i\}) := \text{avg}(\{g_i\})$$
$$:= \text{CM}(\{g_i\})$$

Examples:

- Coordinate-wise median [Yin et al. 2017]
- Krum [Blanchard et al. 2018]
- Geometric median / RFA [Pillutla et al. 2019]



# Byzantine-robust training



❖ **Mean vs median**



# Negative result

- ❖ Robustness of the aggregation rule  $\text{agg}(\{\mathbf{g}_i\})$  does **not** imply robust training:  
*time-coupled attacks - "little is enough"*
- ❖ Any aggregation rule which does not use history can **fail** for training (convergence)



# Fix: Using history with momentum

- ❖ Simply use worker momentum

$$\mathbf{m}_i := (1 - \beta)\mathbf{g}_i + \beta\mathbf{m}_i$$

- ❖ Effectively averages past gradients, reducing variance

- ❖ (Robustly) aggregate worker momentum instead of gradients

$$\mathbf{w} := \mathbf{w} - \gamma \text{agg}(\{\mathbf{m}_i\})$$



# Robustness vs Fairness

Objective

**Robust mean**

robust-mean<sub>*i*</sub>  $f_i(\mathbf{x})$

$$= \frac{1}{|good|} \sum_{i \in good} f_i(\mathbf{x})$$

**Federated**

$$\frac{1}{n} \sum_i^n f_i(\mathbf{x})$$

**Fairness**

$$\max_i f_i(\mathbf{x})$$

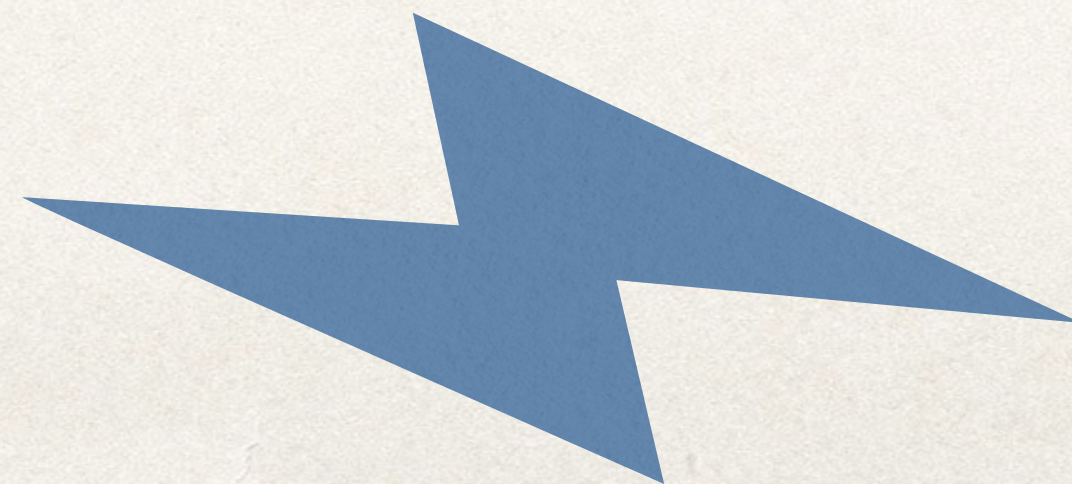



3b

# Adversarial Attacks (at inference time)

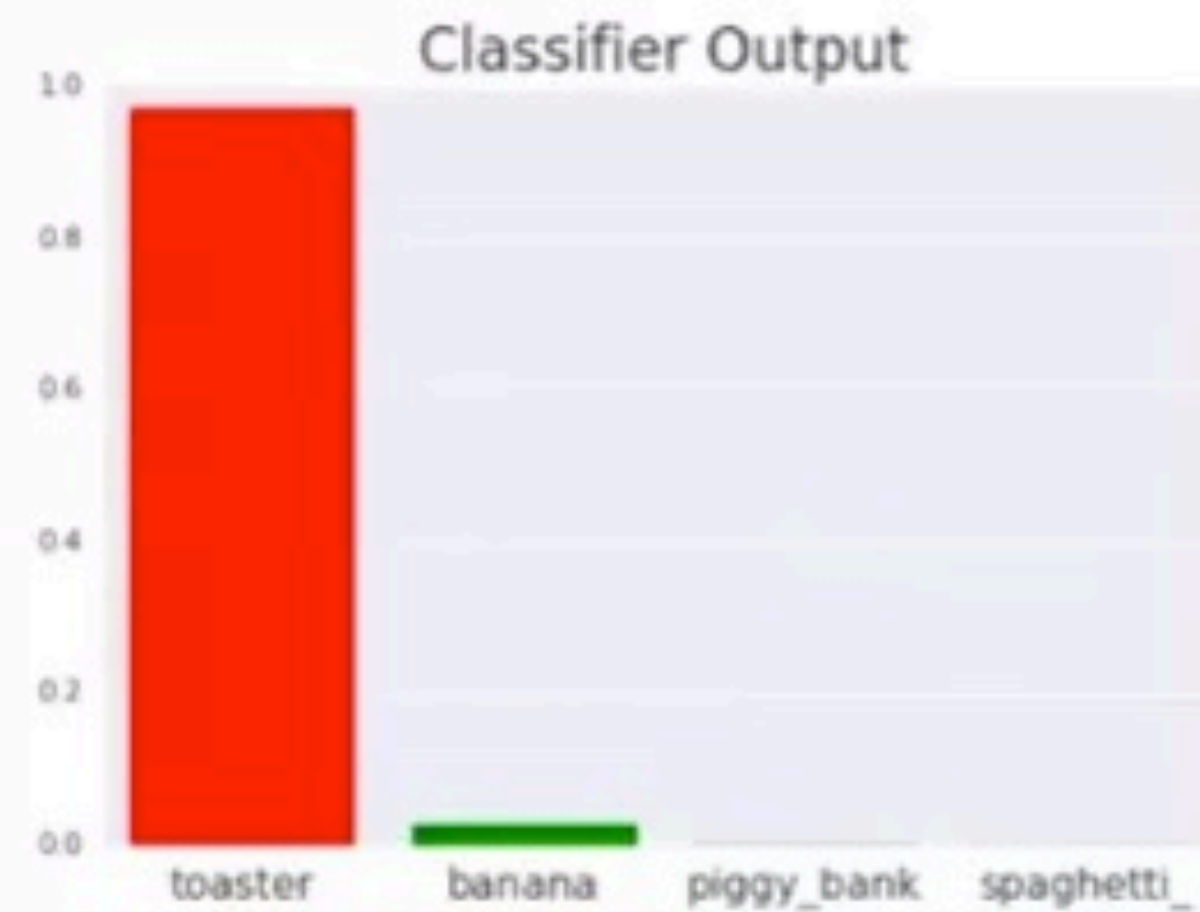
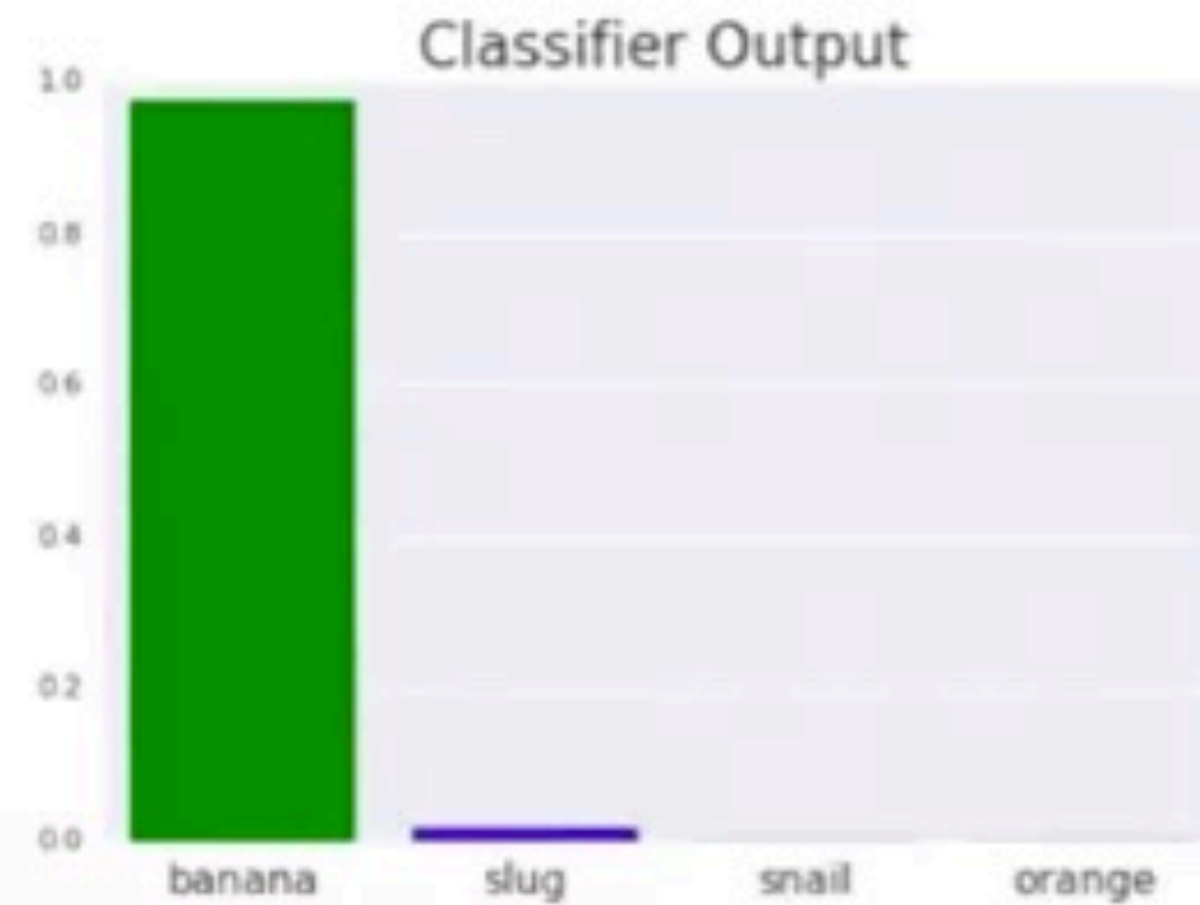
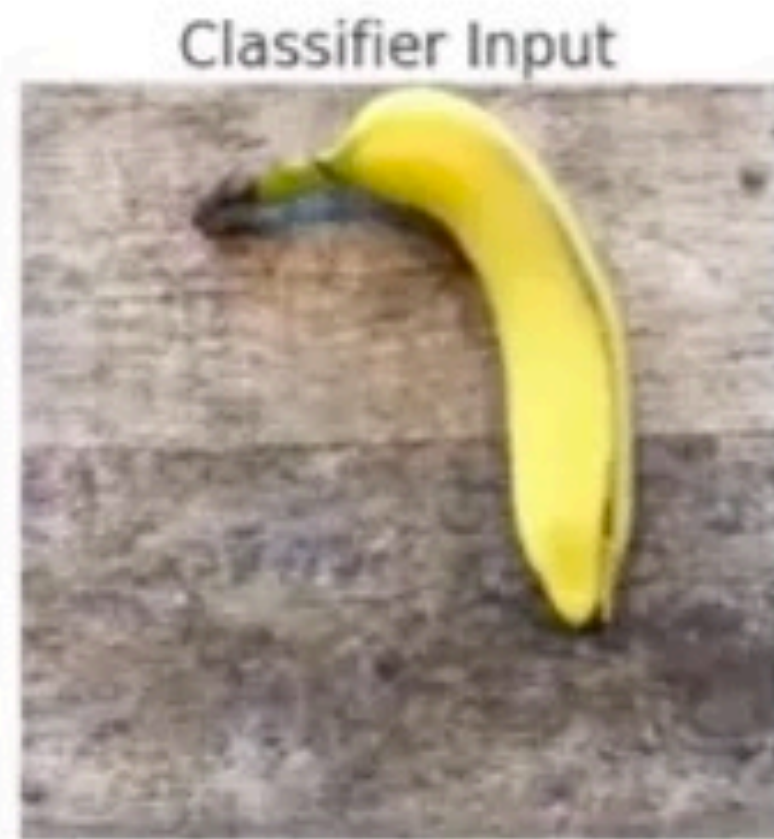

Image: Elsayed, Papernot et al 2018



# Adversarial Attacks (at inference time)

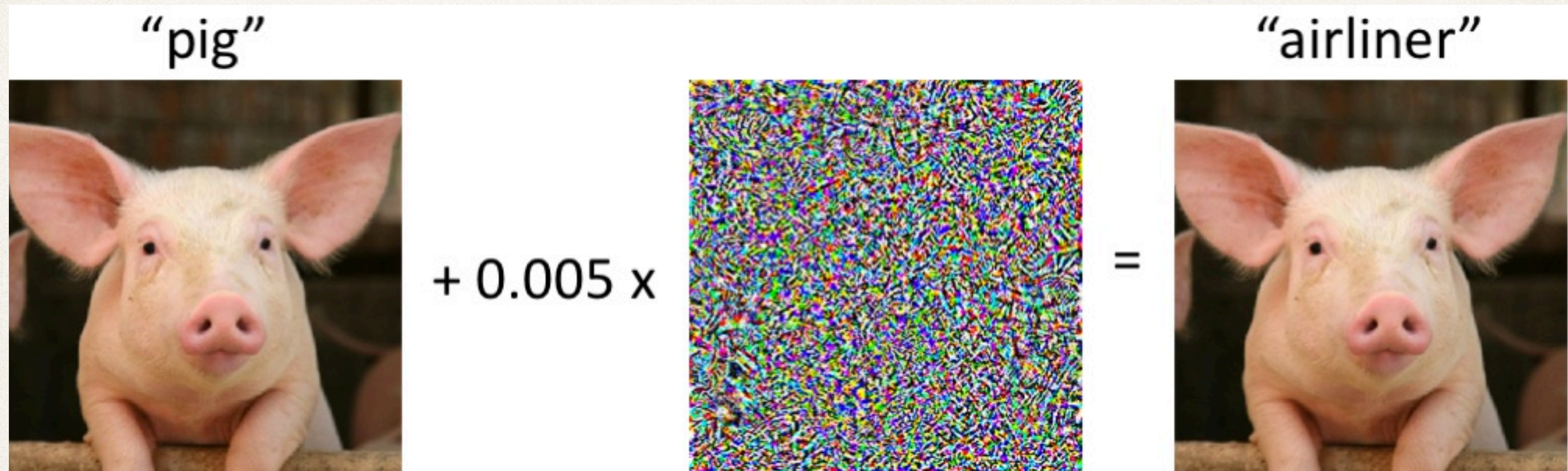

Image: [Mądry, Schmidt](#)

More info:  
[http://gradientscience.org/intro\\_adversarial/](http://gradientscience.org/intro_adversarial/)



# Adversarial Attacks

- ❖ Standard training

$$\min_{\mathbf{w}} f_{\mathbf{w}}(\mathbf{x}_i)$$

$$\nabla_{\mathbf{w}} f$$

change model

- ❖ Attacking

$$\max_{\mathbf{x} \in R_{\infty}(\mathbf{x}_i, \varepsilon)} f_{\mathbf{w}}(\mathbf{x}_i)$$

$$\nabla_{\mathbf{x}_i} f$$

change data

- ❖ by Projected Gradient Descent!



# 4

## Privacy

- ❖ Secure Multiparty Computation
  - ❖ secure aggregation  
(private gradients, public model)
- ❖ Differential Privacy
- ❖ Privacy / inference Attacks



# 5

## Leveraging Heterogenous Systems

Compute & Memory Hierarchy: Which data to put in which device?

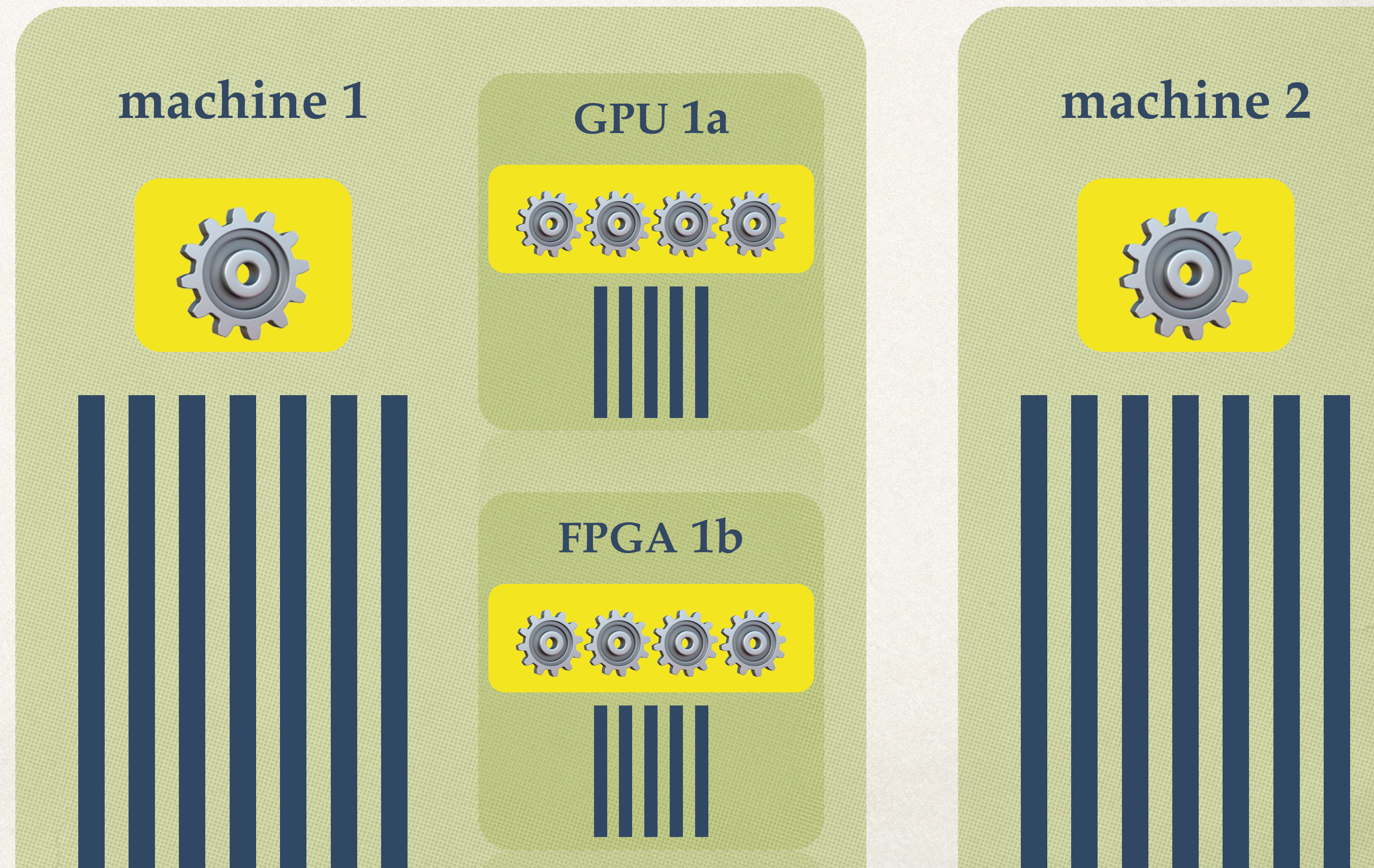



# Leveraging Heterogenous Systems

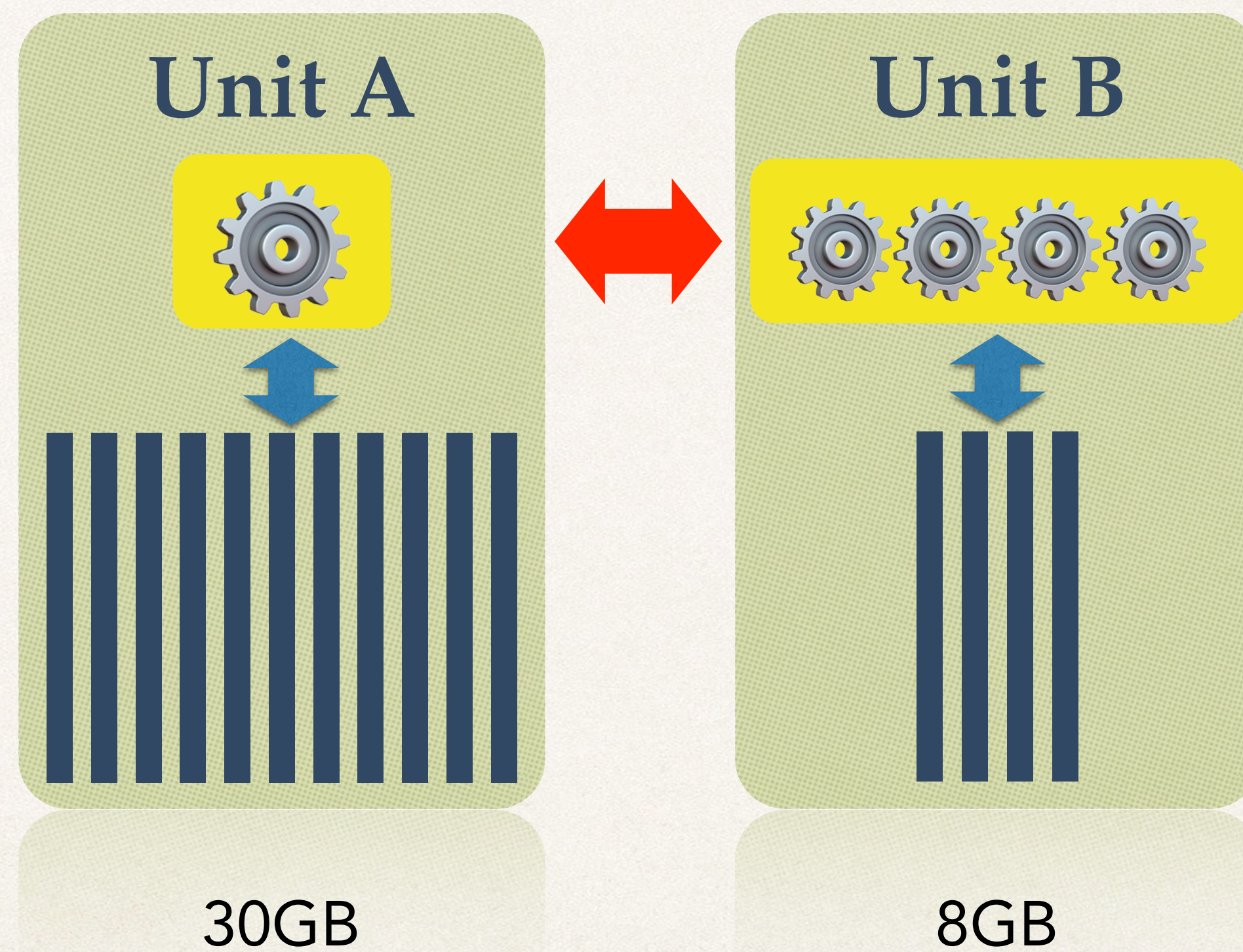

adaptive importance sampling of datapoint  
e.g. for general linear models, or word2vec



# Trends - Systems

- ❖ **new hardware**
  - ❖ TPU, GraphCore, Cerebras
  - ❖ sparse ops
  - ❖ efficient numerics (limited precision), model compression
- ❖ **Software frameworks**
  - ❖ AutoGrad (Jax, PyTorch, TensorFlow etc)
  - ❖ Backends for new hardware

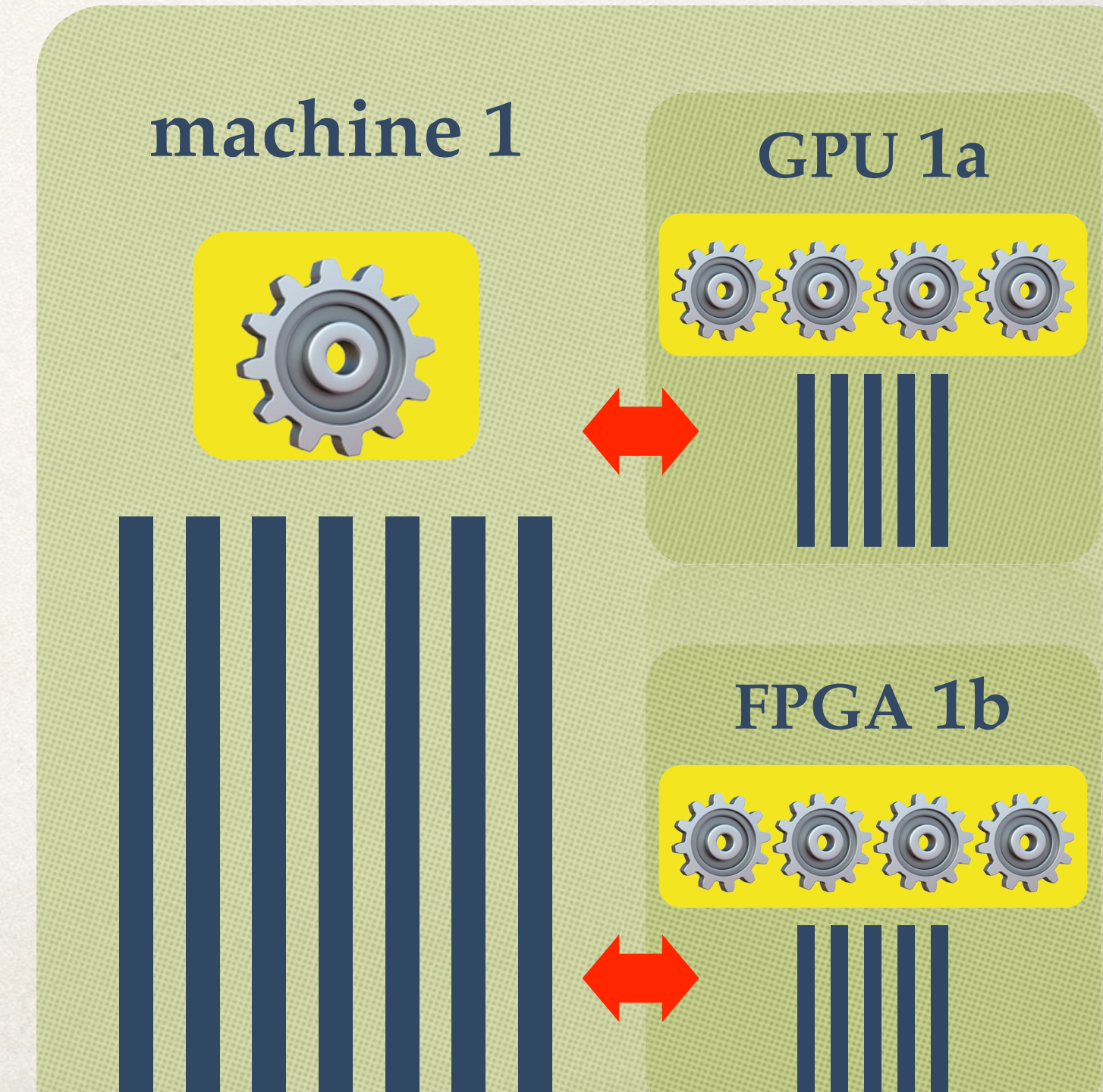



# Number formats for DL

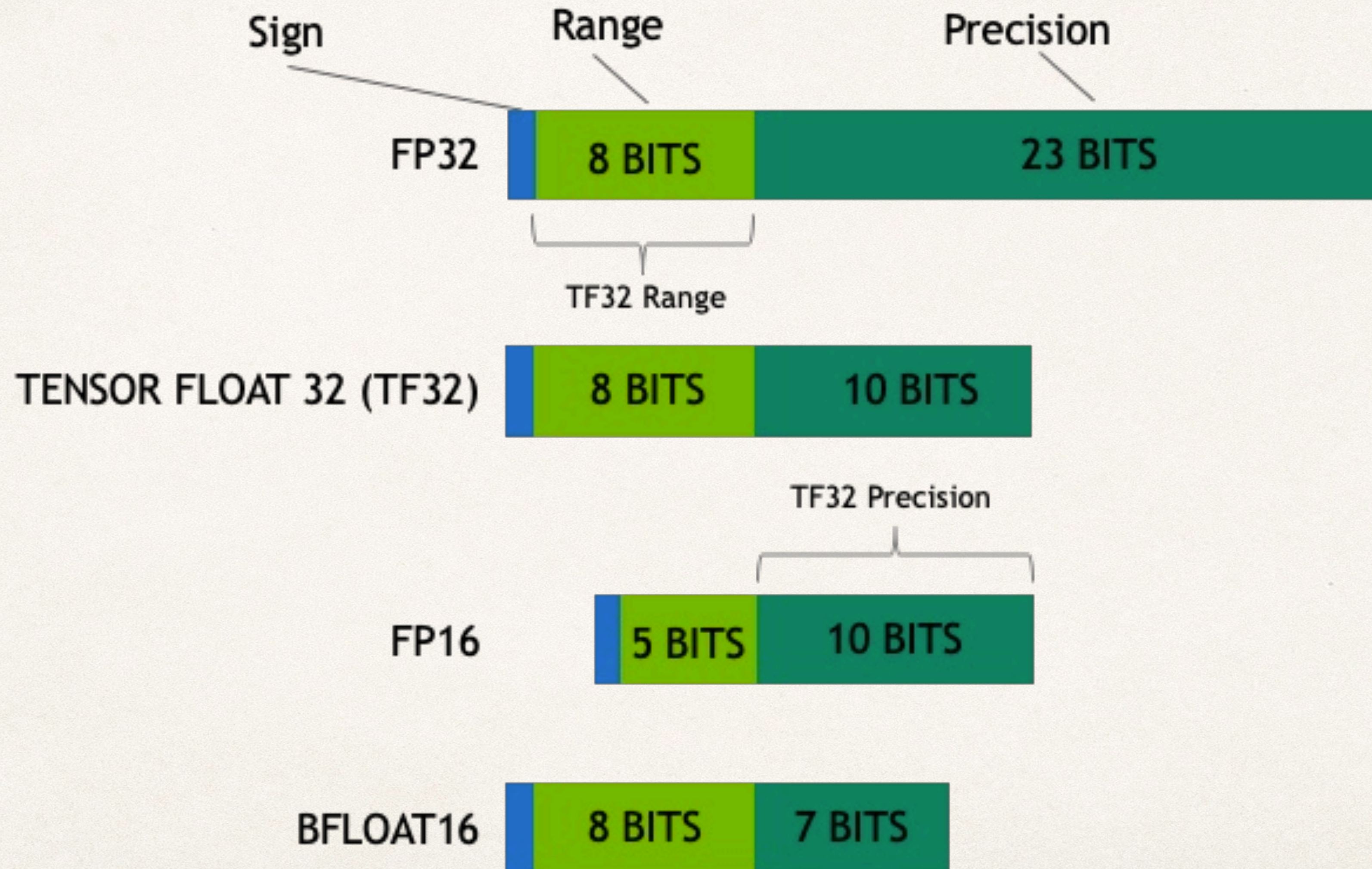



# Practical tricks

❖ feature hashing

❖ limited precision operations

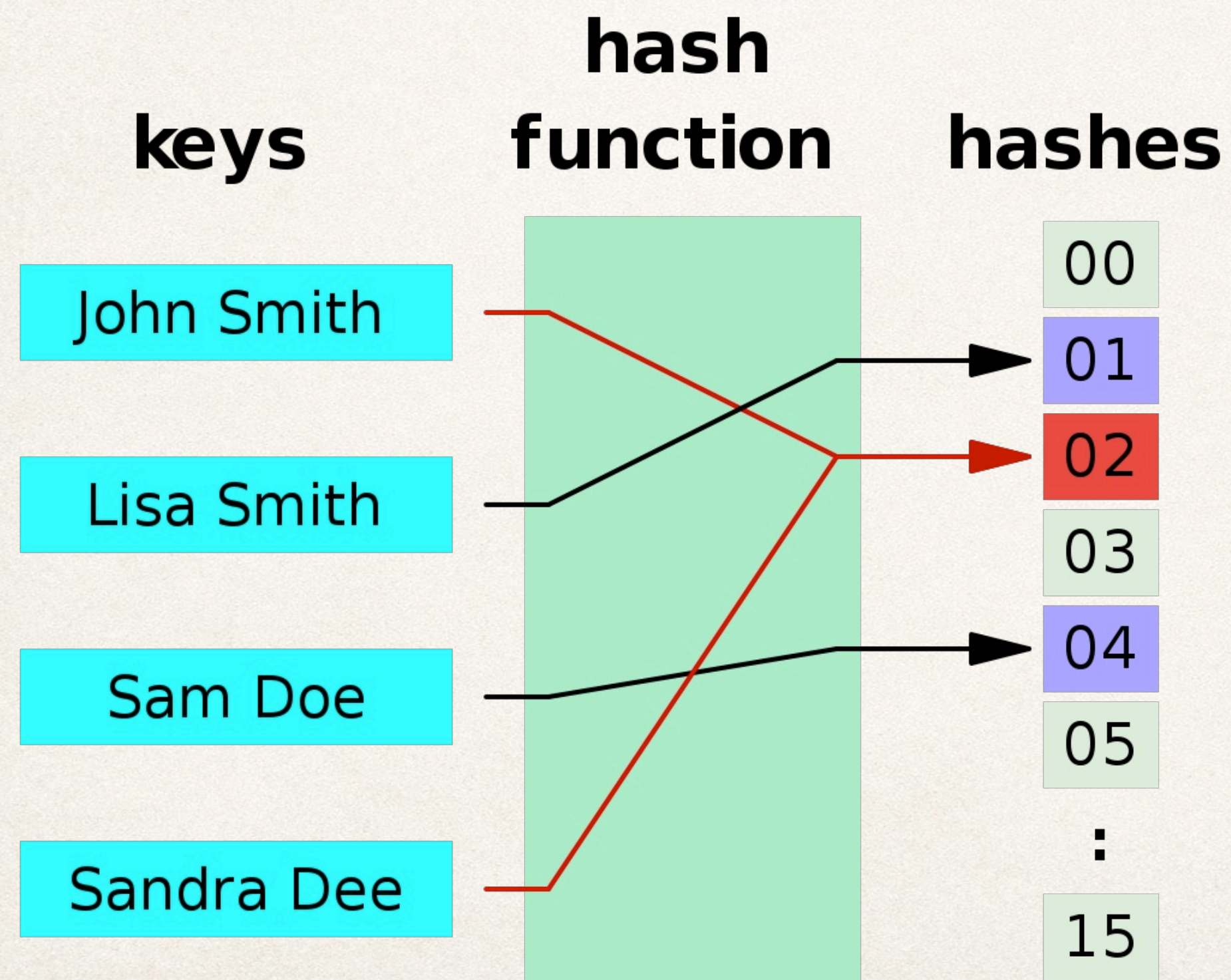



# Auto ML

- ❖ **hyper-parameter optimization**  
*zero-order methods*
- ❖ **learning to learn**  
*adaptive methods*
- ❖ **neural architecture search**  
*zero-order, warm-start*



Thanks!

[mlo.epfl.ch](http://mlo.epfl.ch)

[tml.epfl.ch](http://tml.epfl.ch)